

AVALON

SPORT / ACCURACY

MANUAL



WARNING

1. Proper training and/or experience are required to lower the risk of serious injury or death. Never use this equipment unless you have:

A) Read this warning label and appropriate owner's manual and packing instructions and completed a "Controlled program of instructions" in the use of this parachute assembly

OR

B) Read this warning label and appropriate owner's manual and packing instructions and completed at least 100 Ram-air parachute jumps.

2. Lower the risk of death, serious injury, canopy damage and hard openings by never exceeding the maximum limits: 136 kg and 159 knots

Parachute systems sometimes fail to function properly even when correctly assembled, packed and operated so that you risk serious injury or death each time you use this or any parachute system!

1. Technical specifications

1.1. Introduction

THE AVALON HARNESS CONTAINER MUST BE CHECKED AND ASSEMBLED BY A QUALIFIED RIGGER.

Before assembly, check the harness, container and all components, ensuring that the Reserve and Main container sizes are compatible with the Reserve and Main canopies, and deployment systems with which it is to be used.

1.2. Description

AVALON is an individual harness container

Main risers with three ring systems

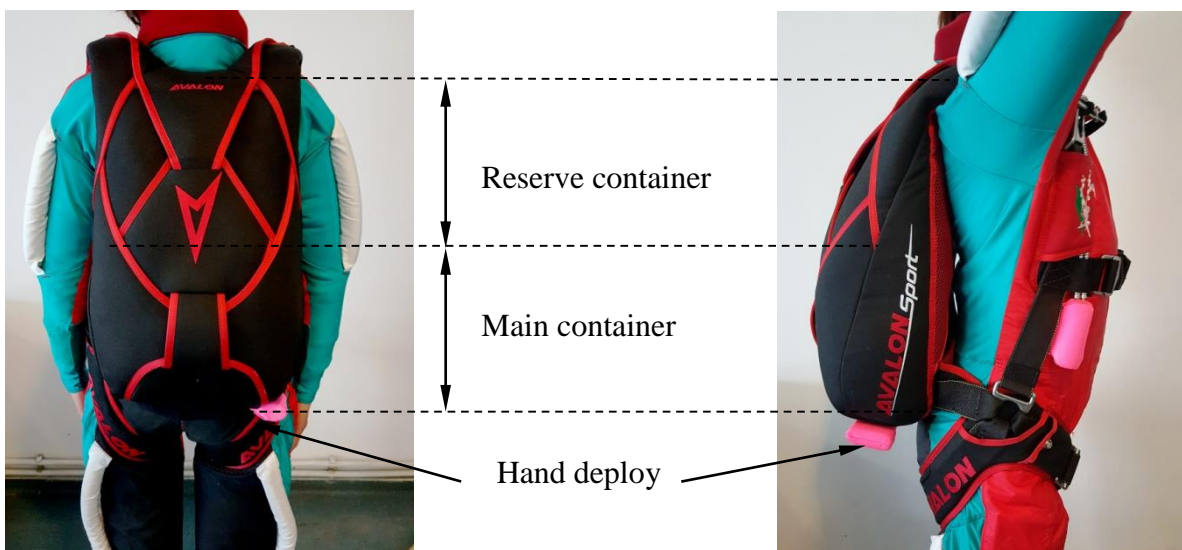

1.3. Marking and list of components

1.3.1. Labels on AVALON harness

These labels are located in a small pocket on the right shoulder of the container.



Parachutes sometimes malfunction even when they are properly designed , built , assembled , packed, maintained and used. The results of such malfunctions are sometimes serious injury or death.

When you use your AVALON you are acknowledging sport parachuting risks and accepting the fact that the AVALON or its components may malfunction. If you are not willing to accept these risks, then you should reconsider you involvement in sport parachuting.

All requirements of SAE AS8015 are observed by:
Advanced Parachute Systems Ltd. , 3400 Montana, Bulgaria
www.avalonskydive.com

 **Advanced Parachute Systems Ltd. Bulgaria**

Container type:.....Harness size:.....
Serial Nr.:.....
Size Main:..... cu.in.
Size Reserve:..... cu.in.
Date of manufacture:.....
Limitations: maximum 136 kg / 150 knots

1.3.2 List of components

Item	P/N	Item	P/N
Reserve Pilot Chute	P/N-010-001	Type-17 Velcro Mini Ring Main Risers	P/N-015-001
Reserve Free Bag	P/N-010-003	Type-17 TruLok Mini Ring Main Risers	P/N-015-002
D Reserve Ripcord	P/N-011-001	Type-17 TruLok Mini Ring Main Risers with Louie Loops.	P/N-015-004
Mini D Reserve Ripcord Pillow	P/N-011-002	Type-8 TruLok STD Large Ring Main Risers	P/N-015-003
Reserve Ripcord	P/N-011-003	Main Trulok Toggles	P/N-014-002
D Reserve Ripcord (Marine eye)	P/N-011-005	Main Velcro Toggles	P/N-014-003
D Reserve Ripcord, (Marine eye)	P/N-011-005	Main Deployment Bag	P/N-010-003
Mini D Reserve Ripcord, (Marine eye)	P/N-011-006	Static Line	P/N-013-006
Mini D Reserve Ripcord, (Marine eye)	P/N-011-007	Main Ripcord	P/N-013-007
Pillow Reserve Ripcord (Marine eye)	P/N-011-010	Reserve Static line (RSL) Lanyard	P/N-013-002
Pillow Soft Reserve Ripcord	P/N-011-012	RSL Universal Lanyard	P/N-013-003
Cutaway Handle	P/N-012-001		
Skyhook RSL Lanyard Complete	P/N-013-001		
Reserve Closing loop	P/N-013-004		
Main closing loop	P/N-013-005		
Reserve Toggles	P/N-014-001		
Main Pilot Chute-F-111-Centerline	Handle options shown below.	Sizes: 27", 30", 33"	
Main Pilot Chute-ZP-Centerline	Handle options shown below.	Sizes: 27", 30", 33"	

1.4. Technical specification and limitations

1.4.1 Specifications and Limitations

The AVALON harness container are build, tested and produced in accordance with TSO-C23D standards and are certified under SAE AS8015 standards.

AVALON containers are produced in different sizes in accordance to the range of the different canopies.

AVALON harness must be used with TSO/EN certified reserve canopies. All canopies used with AVALON harness container must meet the size and packing volume shown on the label.

Limitations:

Maximum Speed:

Maximum weight is defined by the lower of the two:

Qualified Reserve deployment system:

Packing:

Main deployment system:

159 knots

kg 136 (300 lbs)

free bag with spring pilot chute as specified in this manual

Deployment bag with hand deploy pilot chute. Static line

1.4.2. Major Components & Accessories:

Cut away handle



Reserve D-handle Mini D-handle with metal cable



Reserve ripcord and metal cable soft pillow



Reserve Toggle

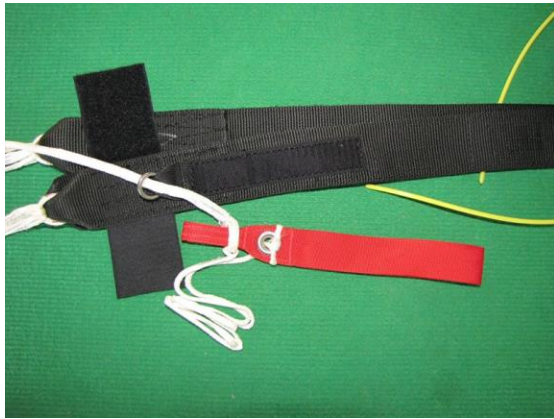

Knife pocket left and right leg strap



For **AVALON Sport-Accuracy** version (**AVALON - SP-AC**) only

Anti-twist Pilot Chute attachment



Main riser extension



Hips Rings and Leg strap type

Reversed Type



Front Type



2. Operating instructions

2.1. Assembly

2.1.1 Inspection before packing

1. Read and understand this manual and be qualified by proper instruction for sport parachuting activities
2. Check both 3 – Ring releases to see that they are correctly assembled, and the release handle is securely with Velcro to the main lift web
3. Check the main container closure for the correct pin position and the correct routing of the bridle.
4. Check the reserve container for the correct pin closure and routing of the ripcord. Be sure the reserve ripcord handle is well seated in its Velcro pocket.
5. The main pilot chute must be protected by its pouch, but the handle must be easily visible and accessible
6. Ensure that the reserve and main canopy size is compatible with the harness-container and deployment system with which it is to be used
7. Prior to assembly and/or packing a thorough inspection of the AVALON harness/container must be completed.
 - Reserve container
 - Main container
 - Harness
 - All cable housings
 - All stitching
 - All grommets
 - Reserve handle integrity and correct size fitted
 - Cut away housing integrity and correct size fitted
 - Reserve risers and deployment brake system

Check for any worn, damaged, corroded or incorrectly rigged components, which must be repaired or replaced before the harness container is packed for use

For Reserve canopy installation, read and follow the instructions included in the Reserve canopy instruction manual.

2.1.2. Reserve canopy assembly

If soft links are used follow the instructions below:

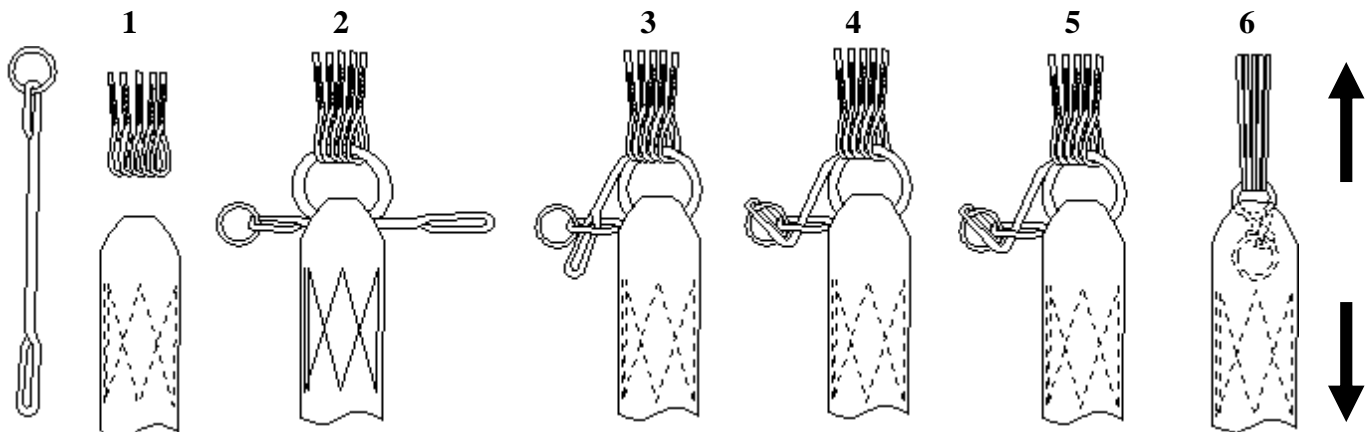

Secure the Soft Link ring in the webbing pocket, and hand tack as shown



If you use connector links:

After canopy installation, don't forget to tighten the connector links (Do not over tighten!).



2.2 Reserve toggle assembly:

Pass the lower steering line through the rear riser ring

Pass the line through the toggle grommet and loop around the toggle. Pull tight.

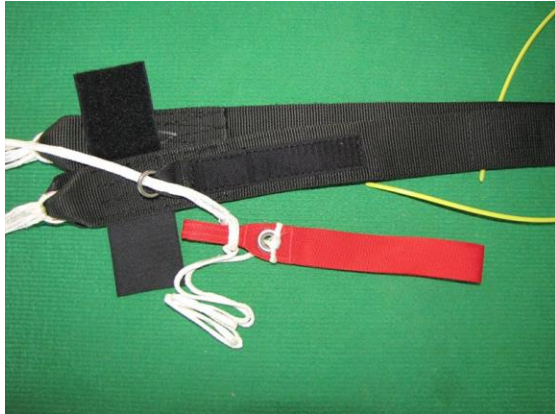

Slide the toggle finger into the pocket. Slow the extra line and close the Velcro. Fix and secure the toggle on the rear riser



2.3 Reserve Canopy lines and risers connection

Connect front lines to the front risers.
Pass the lines through the slider grommets

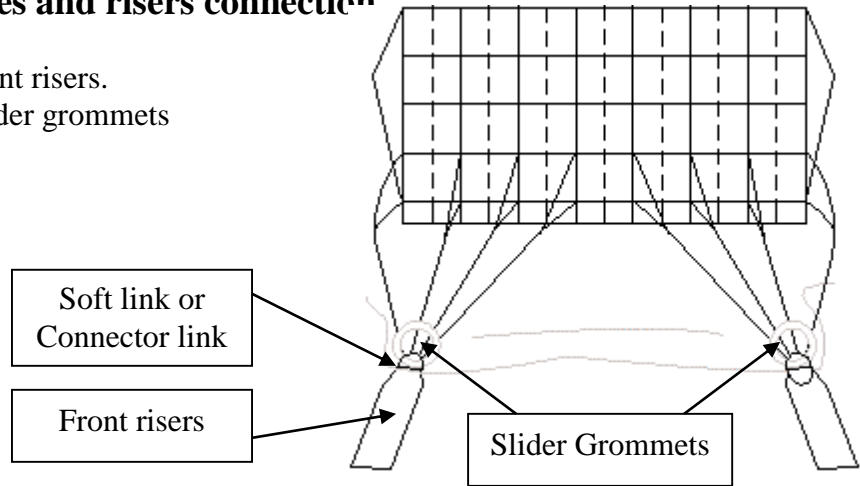

Connect rear lines..
Pass the line through the slider grommets.

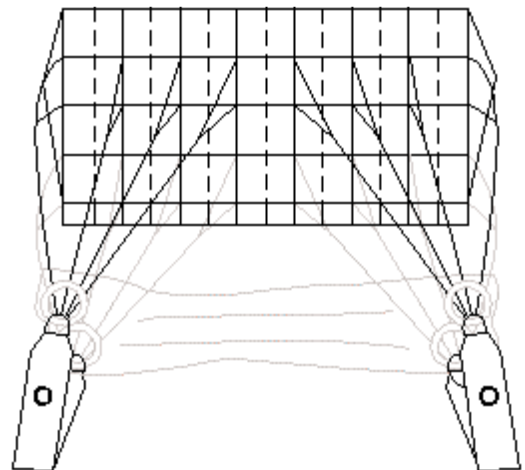

Connect the steering lines.
Pass the steering line through the rear slider grommet and through the guide ring on the rear reserve riser.

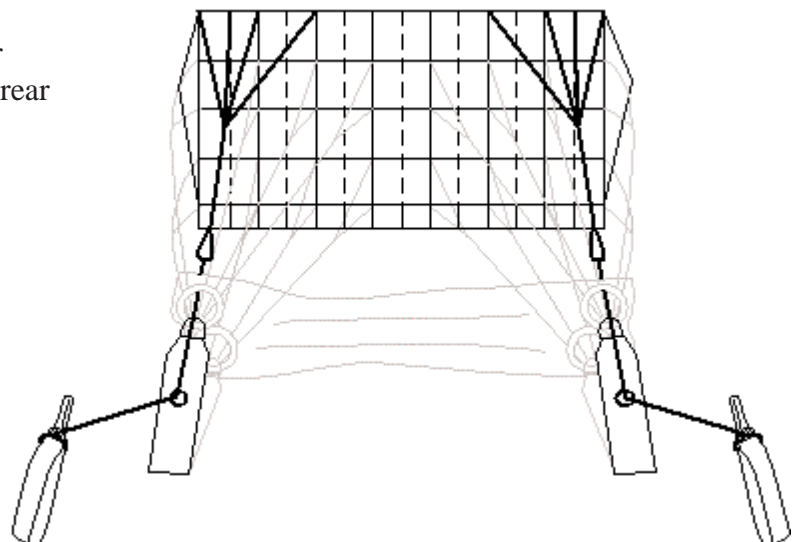

Mandatory: Only use an AAD closure loop with the AVALON Harness/Container

To set the reserve closure loop and washer use the following method as shown:



Adjust the length and tighten the knot

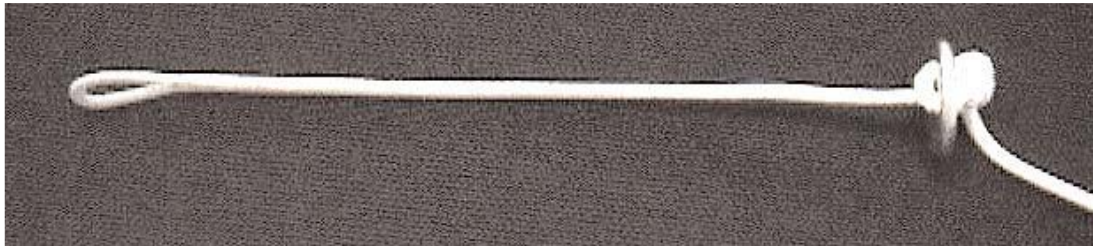

2.4 AAD Unit installation

By installing the AAD follow the positions shown on the pictures

Insert the AAD into the pocket.



Route the AAD control unit through the backpack .

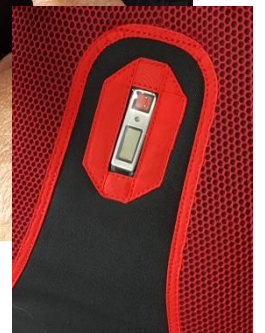
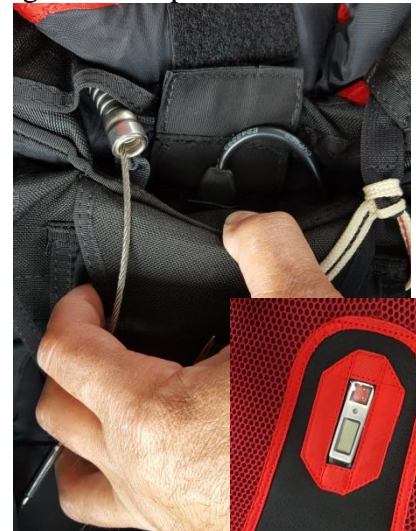

Roll excess cable and cover it with the small flap. Then insert the cutter following the next steps (step 1, step 2, step 3 , step 4)



Insert the cutter under the small belt and align the cutter hole with that of the closing flap.



2.5 Reserve Canopy packing

For packing of the Reserve Canopy, follow the Reserve canopy manufacturer's WARNING, instructions and recommendations.

For the closing of the Reserve Container follow the AVALON Manuals WARNINGS, Instructions and recommendations. Packing of the Reserve Canopy and Container must be completed by a qualified rigger.

Set the toggle into the lower steering line brake loop. Slide the toggle finger into the pocket. Stow the extra line and close the Velcro. Fix and secure the toggle on the rear riser.

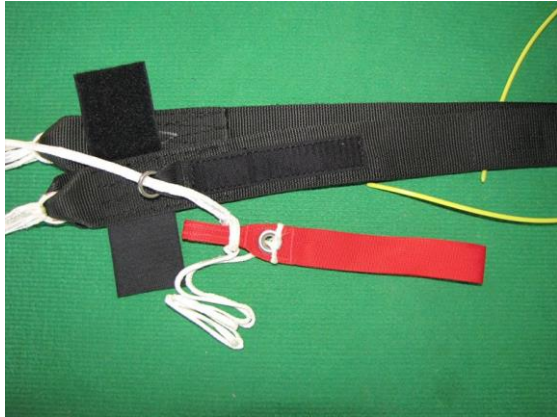

Prepare the reserve deployment bag shape as shown

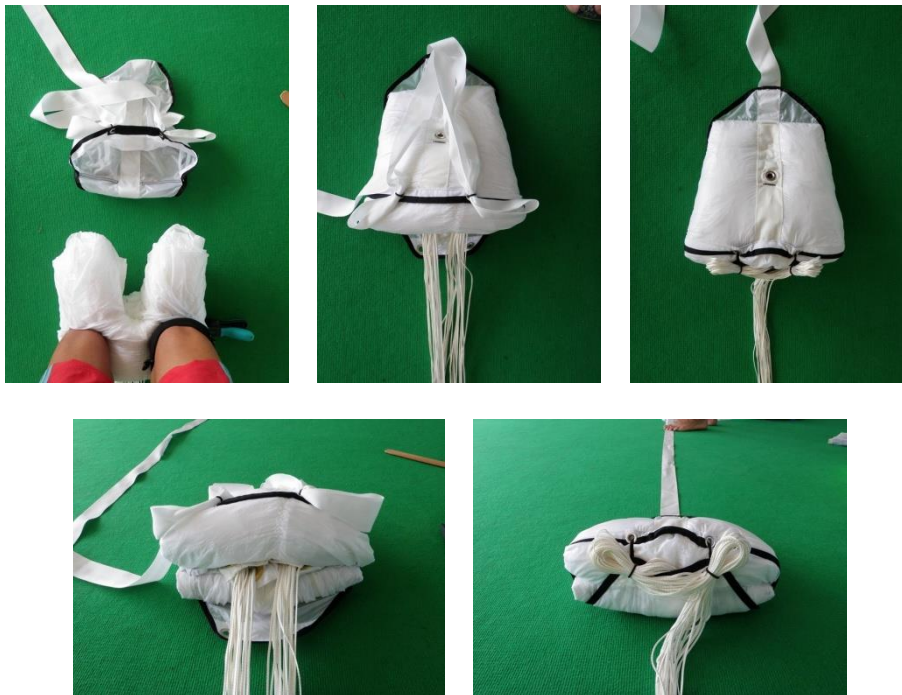

2.6 Fast opening Rescue System assembly (FORS)

Prepare the RLS Lanyard

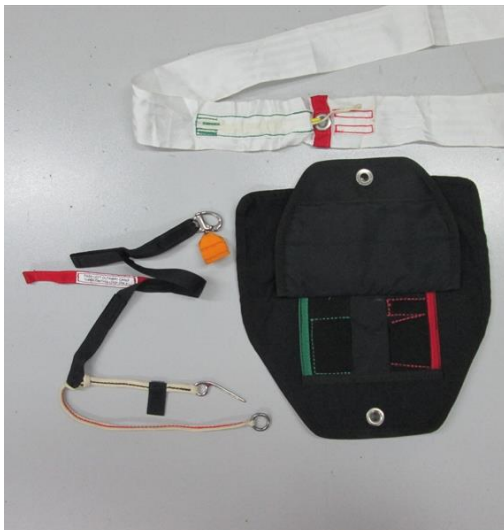

Lay the risers flat against the container wall and place the Free bag in the reserve container. Pass the Reserve loops through the Free bag grommet. Close flap #1.

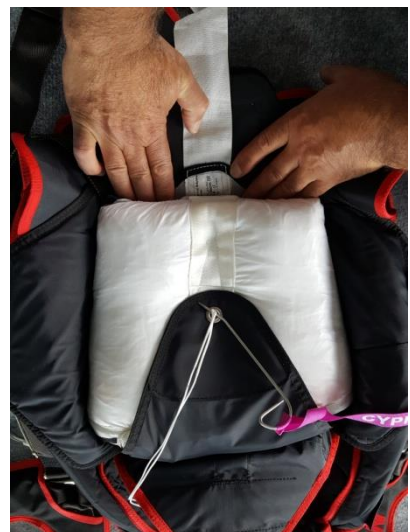

Fold the Reserve bridal as shown. Close flap #2



Check if the white FORS lanyard is in place.

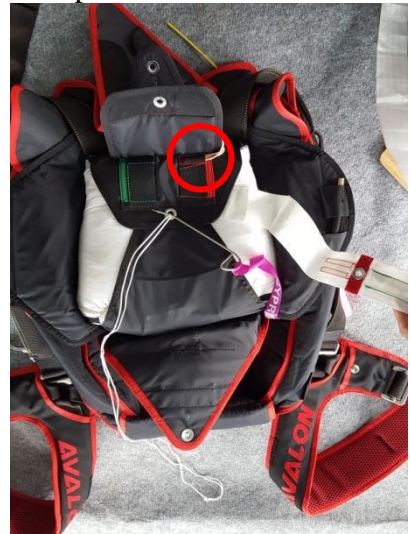

Pass the FORS connection loop through the lanyard ring.

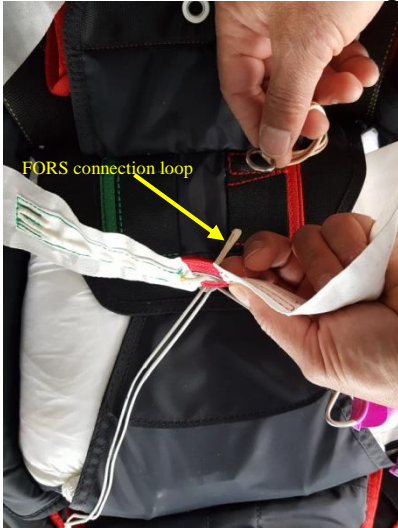

Back the FORS connection loop through the bridal grommet and secure it with the FORS yellow cable.

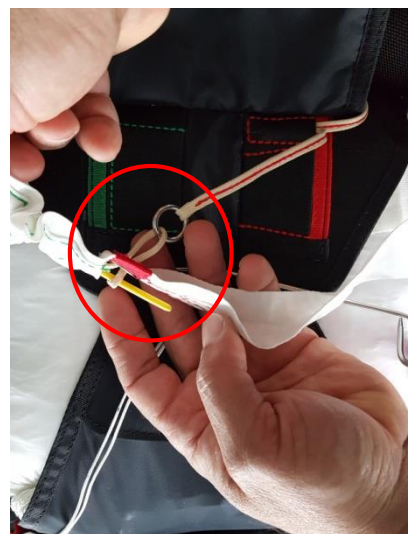

Fold the green marked part of the bridral and poke it into the green marked area.

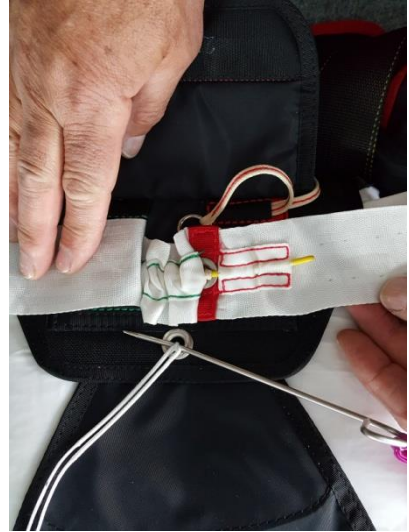

Fold the red marked part of the bridral and poke it into the red marked area. Close flap #2A



Fold the rest of the bridral above flap #1. Pass the pull up cord cleanly through the pilot chute from bottom to top plate and look the pilot chute in position with a temporary pin.

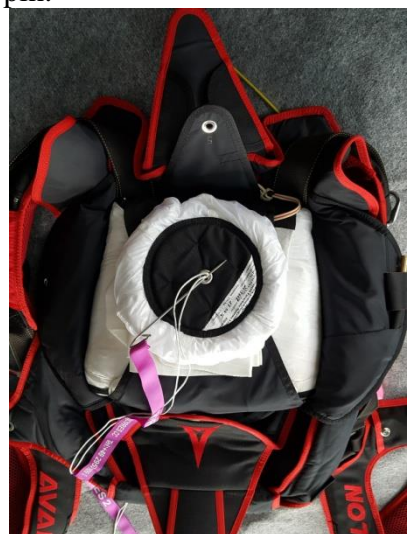

To ensure proper AAD activation, make sure your loop is threaded through the AAD. Close Flap #3



Close Flap #4 and Flap #5



Install the reserve pin through the reserve cable eye. Insert the pin through the closing loop and poke it under the protector pocket. Close the reserve top flap.



!!! ATTENTION !!!
AVALON Container from
SN:2019953 and after,
please follow the closing
steps on the next page
below

After You close Flap #4 close Flap #5 and Flap #6. Install the reserve pin through the reserve cable eye. Insert the pin through the closing loop and poke it under the protector pocket. Close the reserve top flap.



2.7 Assembling AVALON container equipped with SkyHook :

If you want to use a Skyhook RSL with your reserve system please follow the installation instructions provided by the manufacturer of the Skyhook RSL and only original parts may be used. After You are ready with **AAD Unit installation**

Place the free bag into the reserve container and close Flap #1. Fold the bridle and close flap #2. Insert the green flex-tab on the freebag bridle into the green pocket on the second flap.



Lay the bridle over the second flap with the Skyhook facing up. Lift the Lexan cover slightly, rotate the Skyhook enough to slip the loop on the end of the red Skyhook lanyard over the Skyhook, and rotate back into position. The Skyhook should be held firmly in place between the two pockets.

Pic.#1. Now close flap 2 A of the container and place the rest of the bridle as shown (Pic.#2 and #3)



Continue closing the container. Pass the pull up cord cleanly through the pilot chute from bottom to top plate and look the pilot chute in position with a temporary pin. To ensure proper AAD activation, make sure your loop is threaded through the AAD. Close Flap #3 and after that close Flap #4 and Flap #5



Install the reserve pin through the reserve cable eye. Insert the pin through the closing loop and poke it under the protector pocket. Close the reserve top flap.

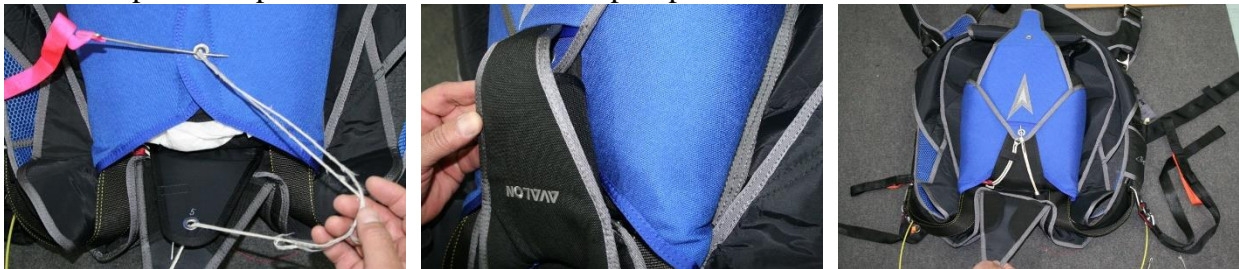

2.8 Main risers and toggles



Pass the steering line through the guide ring and connect the toggle to the steering line as shown

Setting deployment brakes



Left hand side

Right hand side

Lateral view

Anti-twist hosing



2.8 Main Canopy Packing

Prepare and pack your main canopy as per main canopy manufacturer manual.

Main container packing

Place the main risers along sidewalls inside external riser covers. After place the main deployment bag into the container with lines facing down



At this stage adjust the closure loop length to suit the main canopy size.



!WARNING! Maximum force exerted by the bridal on the curved pin must not be more than 6 daN. For safety reasons the minimum force exerted must not be less than 4 daN.



After adjustment of the loop, pull it till washer and knot are in the webbing pocket.

Pass the loop through the flaps as shown below. Follow the number written on the container flaps.

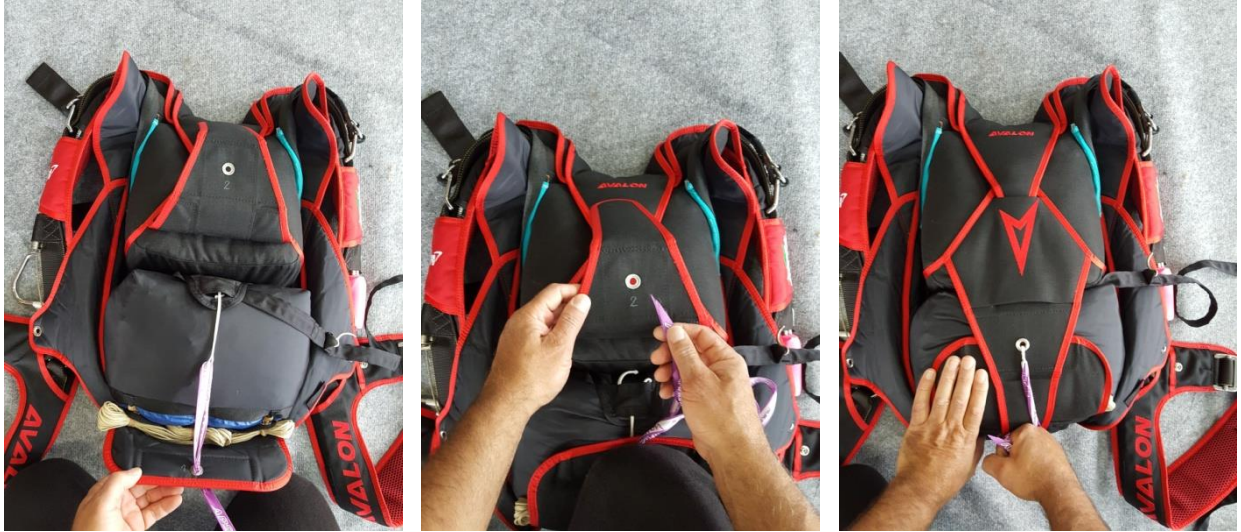

After closing all container flaps insert the closing pin. Make sure the bridled is exiting from the top right of the flap. Slide the remaining bridled under the right flap.

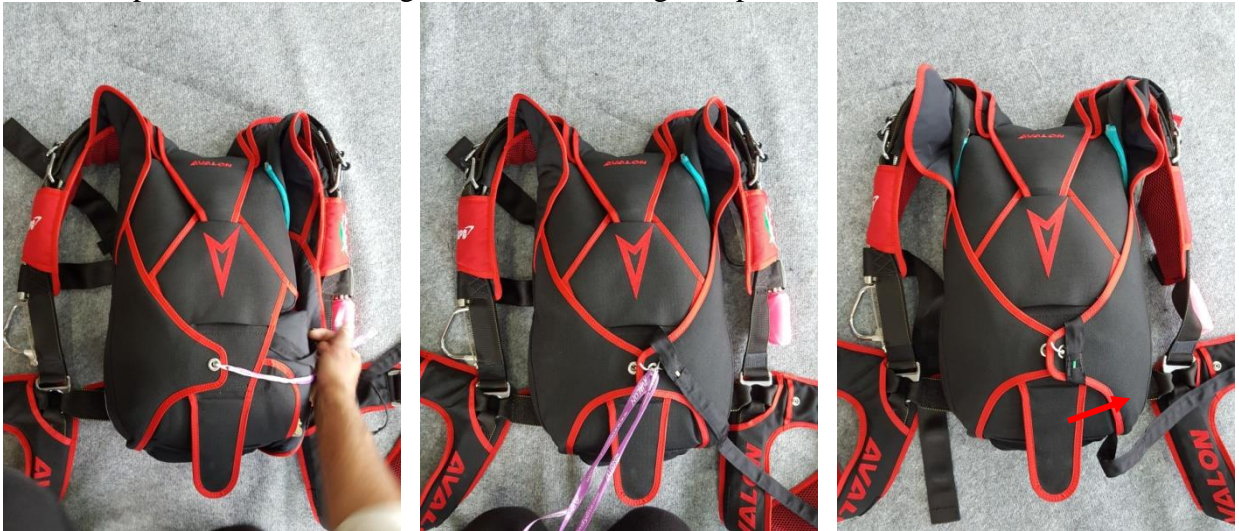

Close the main pin cover flap.



Close the magnet riser covers.



Folding the pilot chute as shown on the pictures below.



Insert the pilot chute in to the BOC pocket and ensure the skydiver can reach the pilot chute handle.

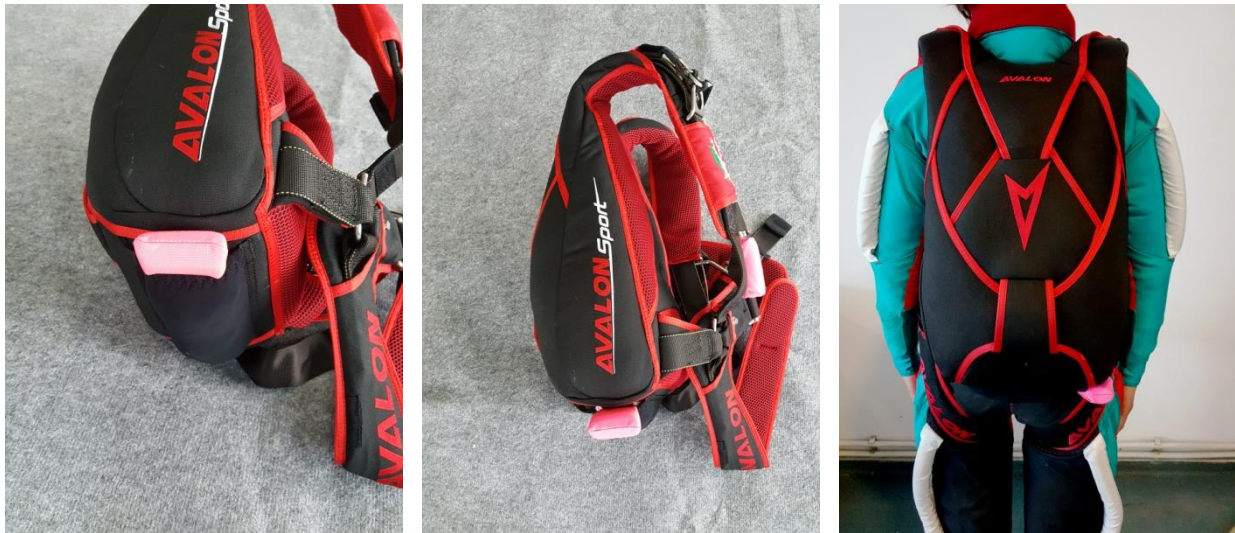

3. Maintenance & Repairs

AVALON MAINTENANCE & REPAIRS

The AVALON is built with the latest design and production technologies.

All maintenance on the AVALON Harness & Container must be done by the Manufacturer or a qualified rigger

Attention:

The label is sewn on the left reserve riser. If this label is not present do not pack the rig.
REMOVAL OF THE CERTIFICATION OR WARNING LABEL VOIDS ALL CERTIFICATION APPROVALS.

3.1 Maintenance frequency:

3.1.1 Reserve:

Reserve maintenance and packing: 1 year in normal* conditions of use and storage
If the conditions are different, the time between maintenance operations may be R reduced by the user.

3.1.2 Main: One month or each 50 jumps

3.2 Maintenance procedure

Operations on the reserve container:

WARNING:

A reserve canopy is not always used in good conditions.

It is possible that your rig or some components are damaged during use (Burns, broken stitching, etc.)

For these reasons it is necessary to check all the minor and major components before taking a decision to reuse and repack it.

IF THERE ARE ANY VISIBLE SIGNS OF WEAR OR DAMAGE, HAVE YOUR RIG INSPECTED A QUALIFIED RIGGER FOR ADVICE ON REPAIR OR REPLACEMENT OF PARTS.

WARNING: NEVER USE SLIDER BUMPERS ON THE RESERVE CANOPY

Check:

- All stitching.
- Webbing – tapes – binding tapes – fabric integrity.
- Plastic plate integrity.
- Hardware for sharp edges or damage
- Grommets for damage

Accessories:

- AAD reserve closure loop replace with new
- Cut away handle cables are in good condition and no damage to cable coating
- Reserve handle for no sharp edges and swaging is in good condition
- Reserve D-bag stitching and grommets. Replace shock cord if damaged
- Reserve bridle is in good condition
- Reserve pilot chute fabric, spring attachment & condition

Operations on the main rig each 50 jumps:

Inspection all components:

Harness container check:

- All stitching
- Webbing – tapes – binding tapes – fabric integrity
- Plastic plate integrity
- Hardware no sharp edges no damage
- Grommets no damage
- Replace Main closure loop with new

Accessories:

- Main D-bag stitching, tapes and change rubber stowing bands
- Main bridle & kill line stitching and kill line condition
- Hand deploy pilot chute stitching & mesh & fabric condition
- Main risers and three ring miniforce check and follow the instructions on page 18 of this manual
- Toggles stitching and Pin

3.3 Storage and use:

Textile (polyamids) and others materials (hardware) used in the construction of all parachutes are sensitive to the following environmental elements.

- Acids (car battery)
- Abrasion
- Chlorine
- Smoke
- Excessive heat 93⁰ C (200⁰ F) and up
- OIL and grease (polyamids)
- Rodents and pests
- Salt water
- Ultra Violet (Sun)
- Water and humidity

When the parachute is not in use it must be placed in a carry bag and stored in a room where the temperature is maintained between 15⁰ C (59⁰ F) and 30⁰ (86⁰ F) C and humidity between 15% and 70%

3.4 User check-list before jump:

- Verify the packing date on the data-card
- Reserve handle in its pocket, and the correct cable routing without tension
- Turn automatic opener (AAD) “ON”
- Cut away handle in his pocket and cable routing correctly into housings
- Correct setting of the 3-ring system and loop condition
- Harness main webbing and leg webbing stitching
- Hardware condition (no grease, no corrosion).
- Main and reserve closure loop condition.
- Hand deploy pilot chute bridle routing
- Curved pin extraction force not over 6 kG/12 lbs
- Hand deploy handle in correct position.

When putting rig on back make sure that the harness and leg webbing is not twisted.

Check position and easy access of:

Main hand deploy handle

- Cutaway handle
- Reserve handle