

# SIGMA

Tandem System Owner's Manual



## INTRODUCTION

### WARNING

Use of this equipment in the United States and its territories should be in accordance with all USPA Basic Safety Requirements (BSR) included within USPA's Skydivers Information manual (SIM), Section 2: Basic Safety Requirements and Waivers.

Use of this equipment outside of the United States should be in accordance with the controlling body for parachuting and skydiving in the country in which the equipment will be used & operated.

Read this information carefully and understand it completely. Any jump that utilizes the Sigma Tandem System is considered a "Tandem jump". Using this system outside the student/tandem instructor training environments is considered a violation of federal law (FAA example No. 4943). Examples of violations: demonstration jumps, stunt jumps, intentional water jumps, night jumps, jumping with any student less than 18 years of age, BASE jumps and Tandem jump that takes place off of a designated drop zone. (These restrictions do not apply to military Tandem applications).

### DISCLAIMER - NO WARRANTY

Because of the unavoidable danger associated with skydiving and the use of this parachute system, the manufacturer makes no warranty, either expressed or implied. The system is sold with all its faults and without any warranty of fitness for any purpose. The manufacturer also disclaims any liability in tort for damages, direct or consequential. These include personal injuries that may be the result of a malfunction, a defect in design & material, workmanship or the manufacturing process whether caused by negligence or otherwise. By using this parachute system or allowing it to be used by others, the buyer waives any liability for personal injuries or other damages arising from such use. If the buyer declines to waiver liability on the part of the manufacturer, buyer may obtain a full refund of the purchase price by returning the parachute system, unused, to manufacturer within 30 days from the date of original purchase with a letter stating why it was returned. Please contact the manufacturer for details.

Neon and fluorescent colored fabrics and tapes fade rapidly. Color brilliance may be lost within a year of manufacture. Uninsured United Parachute Technologies, LLC assumes no responsibility for this condition

### CONTACT INFORMATION

If you have any questions, comments or suggestions after reading this manual, please feel free to contact us.

Uninsured United Parachute Technologies, LLC is open Monday through Thursday, from 8 am to 5 pm EST, Friday 8am to 12 pm EST.

Uninsured United Parachute Technologies, LLC  
1645 Lexington Avenue  
DeLand, FL 32724-2106  
USA

P: +1 386 736 7589

F: +1 386 734 7537

RIGGING LOFT:

P: +1 386 736 7471

<http://www.uptvector.com>

upt@uptvector.com

## A WORD FROM THE OWNER



Dear Skydiver,

Congratulations on your purchase of the Sigma Tandem harness and container system - without question the safest and most reliable tandem system on the market today.

Here at Uninsured United Parachute Technologies, LLC, we are totally committed to you, our customer, through the quality and performance in the harness and container systems we design, build and deliver. We have stood behind our products 100% from the day they leave our factory and reach your doorstep, and have done so for over 30 years. You will find our service after the sale to be as comprehensive as our customers have come to expect from Uninsured United Parachute Technologies, LLC. When you buy a Sigma, you're buying more than a tandem system; you're buying innovation, quality, reliability and most of all a product that has survived the test of time. Uninsured United Parachute Technologies, LLC has built more sport, student and tandem harness/container systems than anyone else in the world.

Thank you again for your purchase of the Sigma. With proper care and maintenance, it should provide you with many years of safe and enjoyable skydiving. Should you have any questions or concerns about your equipment, please do not hesitate to contact us.

Blue skies!

A handwritten signature in black ink that reads "Bill Booth".

Bill Booth  
President, Uninsured United Parachute Technologies, LLC

**CONTENTS**

<b>INTRODUCTION</b>	<b>ii</b>
WARNING	ii
DISCLAIMER - NO WARRANTY	ii
CONTACT INFORMATION	ii
A WORD FROM THE OWNER	iii
CONTENTS	iv
<b>SECTION 1: THE SIGMA TANDEM SYSTEM</b>	<b>1</b>
<b>CHAPTER 1: INTRODUCTION &amp; FEATURES</b>	<b>2</b>
SIGMA TANDEM INTRODUCTION	2
THE ADVANTAGES OF THE SIGMA TANDEM	2
SIGMA TANDEM EQUIPMENT LIMITATIONS	2
SIGMA TANDEM FEATURES IN DETAIL	3
<b>CHAPTER 2: APPLICANT INFORMATION</b>	<b>5</b>
APPLICANT QUALIFICATIONS	5
COURSE REQUIREMENTS	5
COURSE SCHEDULE & ACTIVITIES	5
PROBATION	6
CURRENCY REQUIREMENTS	7
RECERTIFICATION	7
RECURRENCY TRAINING	8
FOREIGN TANDEM RATINGS	8
<b>SECTION 2: EQUIPMENT</b>	<b>9</b>
<b>CHAPTER 1: DESCRIPTION</b>	<b>10</b>
HARNESS & CONTAINER	10
THE STUDENT HARNESS	11
THE SIGMA II MAIN CANOPY	12
THE DROGUE SYSTEM	13
THE MAIN RECOIL RIPCORDER SYSTEM	15
THE SKYHOOK RSL AND INTEGRATED COLLINS LANYARD	16
<b>CHAPTER 2 - OPERATION</b>	<b>17</b>
IMPORTANT	17
VERTICAL SUSPENDED DRILLS	17
THE SKYHOOK RSL AND INTEGRATED COLLINS LANYARD	17
RESERVE ACTIVATION	17

MAIN ACTIVATION	18
CANOPY BRAKES & STEERING SYSTEM	18
DONNING AND ADJUSTING THE SIGMA TANDEM	19
STUDENT HARNESS FITTING & ADJUSTMENT	19
STUDENT HARNESS ATTACHMENT PROCEDURE	20
<b>CHAPTER 3 – RESERVE PACKING &amp; CLOSING</b>	<b>21</b>
INSTALLATION OF AAD	21
SIGMA 2 RESERVE CANOPY INSPECTION	24
RECOMMENDED TOOLS	24
ASSEMBLY OF RESERVE CONTAINER COMPONENTS.	25
LINE BUMPER INSTALLATION	28
VR360 VTC-II (L BAR INSTALLATION)	32
SETTING RESERVE BRAKES SIGMA 2 RESERVE	34
SETTING RESERVE BRAKES VR360/VTCII	36
PACKING RESERVE CANOPY-VR360/VTCII	43
PACKING THE SIGMA 2 RESERVE CANOPY	57
OPTIONAL STAGING LOOP INSTALLATION	82
<b>CHAPTER 4 – MAIN PACKING &amp; CLOSING</b>	<b>87</b>
SELECTING THE CORRECT STOW BANDS	87
INSPECTING MAIN CANOPY & COMPONENTS	87
ASSEMBLING THE MAIN CANOPY TO THE MAIN RISERS	87
ATTACHING THE PRIMARY & SECONDARY TOGGLES	89
ATTACHING MAIN BAG AND DROGUE	91
ATTACHING MAIN BAG AND DROGUE	93
SETTING MAIN CANOPY BRAKES	95
PACKING THE MAIN CANOPY	96
PACKING & STOWING THE DROGUE	111
<b>SECTION 3: INSTRUCTOR TECHNIQUES</b>	<b>114</b>
<b>CHAPTER 1: PREPARATION</b>	<b>115</b>
REQUIREMENTS FOR JUMPING	115
OVERVIEW OF THE JUMP	116
BRIEFING THE STUDENT FOR THE FIRST JUMP	116
STUDENT HARNESS ADJUSTMENT	118
PRE-FLIGHT GEAR CHECK	118
<b>CHAPTER 2: IN-AIRCRAFT &amp; EXITS</b>	<b>120</b>
IN-AIRCRAFT GEAR CHECK	120

EXITS	120
<b>CHAPTER 3: FREEFALL / DROGUE FALL</b>	<b>122</b>
ALTITUDE RECOMMENDATIONS AND REQUIREMENTS	122
STABILITY CONTROL	122
DEPLOY DROGUE	123
DROGUE FALL TECHNIQUES	123
ARM EXTENSION (OPTIONAL)	124
DROGUE RELEASE	124
<b>CHAPTER 4: CANOPY / LANDING</b>	<b>125</b>
UPON OPENING	125
STEERING THE CANOPY	125
LANDING	126
WATER LANDINGS	127
<b>SECTION 4: MALFUNCTIONS &amp; EMERGENCIES</b>	<b>128</b>
<b>CHAPTER 1 – RESERVE PROCEDURE</b>	<b>129</b>
EMERGENCY RESPONSE SEQUENCE	129
RESERVE PROCEDURES	129
RESERVE CANOPY	130
MALFUNCTION PROCEDURE DIAGRAM	131
<b>CHAPTER 2: IN AIRCRAFT</b>	<b>134</b>
AIRCRAFT EMERGENCIES	134
STUDENT REFUSAL	134
<b>CHAPTER 3: EXIT &amp; FREE FALL/DROGUE FALL</b>	<b>135</b>
UNTIMELY CANOPY DEPLOYMENTS	135
EXIT PROBLEMS	135
DROGUE DEPLOYMENT PROBLEMS	136
DROGUE FALL PROBLEMS	137
DEPLOYMENT PROBLEMS	137
<b>SECTION 5: STUDENT TECHNIQUES</b>	<b>140</b>
<b>CHAPTER 1: STUDENT SKILLS</b>	<b>141</b>
EQUIPMENT	141
EXIT PRACTICE	141
EXIT & FREEFALL POSITIONS	141
CANOPY CONTROL	142

EXIT & FREEFALL POSITIONS	143
<b>CHAPTER 2: OTHER ACTIVITIES</b>	<b>144</b>
PARTICIPANTS QUALIFICATIONS	144
HAND-CAMERA PROCEDURES	144
RW TANDEM BRIEFING	144
CANOPY SEPARATION REQUIREMENT	145
<b>SECTION 6: CARE &amp; MAINTENANCE</b>	<b>146</b>
<b>CHAPTER 1: CARING FOR YOUR SIGMA</b>	<b>147</b>
RECOMMENDED COMPONENT LIFESPANS	147
RESERVE COMPONENT LIFESPANS	147
INSPECTING YOUR SIGMA	147
3 RING RELEASE SYSTEM	148
SOURCES OF EQUIPMENT DEGRADATION	149
REPLACEMENT PARTS	149
ILLUSTRATED PARTS LIST	150
MEASURING THE SIGMA DOME SLIDER	153
SIGMA 2 RESERVE CANOPY TECHNICAL INFORMATION	154
LINE TRIM CHART SR-340, 370	156
SYSTEM WEIGHTS	158
DROGUE KILL LINE CALIBRATION	159
REVISION LOG	163

**SECTION 1: THE SIGMA TANDEM SYSTEM**

CHAPTER 1: INTRODUCTION & FEATURES

CHAPTER 2: APPLICANT INFORMATION





## CHAPTER 1: INTRODUCTION & FEATURES

### SIGMA TANDEM INTRODUCTION

For over 10 years, the Sigma Tandem System has led the way forward in safety, comfort, and convenience. Unlike other tandem systems, where the drogue was simply “added on” to existing containers, the Sigma Tandem was designed “from the ground up” as a drogue deployed tandem system. It utilizes a drogue attachment system that is integral with the main container closing system. When the main container opens, the drogue is released. One cannot happen without the other. Once the main container is closed, the drogue is then stowed exactly like a bottom-of-container hand-deploy pilot chute normally seen on solo systems. The advanced Drogue release system combined with many other unique features makes the Sigma Tandem the best choice on the market.

### THE ADVANTAGES OF THE SIGMA TANDEM

- It takes fewer steps, with fewer potential errors to close the main container.
- Accidentally snagging the drogue bridle will not open the container.
- Out-of-sequence deployments are virtually eliminated.
- Its center-of-main-container drogue connection gives a more “natural” and comfortable drogue-fall position.
- The drogue release ripcords are automatically retracted after use, or accidental snagging, so that they are always where they should be, cannot be lost, and don’t have to be stowed after pulling.
- It has two redundant drogue release ripcords, one on the right and one on the left.
- The drogue release/container opening pin is “locked” until you throw the drogue, minimizing the possibility of accidental high openings.
- No more time-consuming untwisting of drogue kill line during packing. Kill lines can be easily replaced in the field. You still get a more or less normal deployment if the kill line breaks, and you don’t lose your drogue.
- Main deployment bag design reduces canopy damage.
- Student harness that is safer and more comfortable for students.
- The Skyhook RSL system.
- The “Collin’s Lanyard,” and all of it’s advantages.
- Tuck tab style reserve pin cover.
- Magnetic riser covers.
- Clear plastic windows make reserve pin checks and AAD operation easier.

### SIGMA TANDEM EQUIPMENT LIMITATIONS

This article meets the minimum performance and quality systems standards required by a technical standard order (TSO). Installation of this article requires separate approval.

The UUPT Sigma Dual Harness/ Container System is built under the TSO C23F. The all up weight (AUW) or maximum combined weight of passengers and equipment shall not exceed 500 lbs (226.8 kg) with a VR360 tandem reserve installed, and shall not exceed 550 lbs (249.5 kg) with either a SR 340 or SR 370 tandem reserve installed. And not to be operated at an airspeed exceeding 175 KEAS (207.1 mph) (333 km/h) in any of these configurations.

The Sigma harness and container system meets the minimum performance and quality system standards required by a technical standard order (TSO). Installation of this article requires separate approval.

The Sigma is the safest and best-selling Tandem system in the world because of its unique design features, many of which are patented. The following information breaks down in detail those features.

## **SIGMA TANDEM FEATURES IN DETAIL**

### **Disc Release System** (Patent: 6,626,400)

At the heart of this system is a specially designed 5-inch diameter disc with a 1 ½" flanged "chimney" at its center, through which the drogue bridle passes. This disc is connected to the bridle, about 3 feet from the deployment bag with a locking pin, which passes through the chimney and a loop on the bridle. To close the main container, and anchor the drogue, you simply place the main bag in the container, and the disc on top of the bag. You then pass the closing loop, which starts on the bottom flap, through custom D-rings on the other three flaps, and then through a grommet back on the bottom flap, in a circular fashion, drawing the flaps snugly around the disc chimney, thus capturing the disc under the four container flaps. The flanged chimney keeps the disc centered in place and allows the drogue bridle to exit the container. The closing loop is secured with an eyeleted metal pin through which two lengths of 1000 lb. Spectra line are looped and then secured a few inches below the final grommet to form a pulley. The other end of each Spectra ripcord passes through its own metal housing, one to the right, and the other to the left. Each drogue release ripcord is attached to a spherical ripcord handle by a lark's head connection, making ripcord replacement in the field quick and easy, without any tools. The system is durable and fail-safe, in that total failure of one ripcord would not affect the function of the other.

### **The Safety Pin** (Patent: 6,626,400)

The system also incorporates a special "safety pin" on the drogue bridle, which locks the main container pin in place until the drogue is deployed. On all other systems, if you snag a drogue release ripcord moving around the aircraft, or on exit, or if you accidentally pull the wrong handle after exit, you end up with a main canopy as soon as you throw your drogue. The unique safety pin minimizes the possibility of this scenario.

### **The Recoil Ripcord** (Patent: 6,626,400)

A single piece of bungee cord passes through both housings and elastically connects the handles to each other. This holds them firmly against the ends of the housings and causes each handle to recoil back into place after being pulled or accidentally snagged. This means the handles will always be where you expect them to be. There is no more stowing of loose handles after opening, and no more looking for handles at packing time. For further security, each ripcord handle is countersunk, so that it snugly slides 3/8 of an inch over the end of its housing. Each ripcord has 3 inches of slack built in, so that it takes a 5- inch pull, on either handle, to release the drogue.

### **The Drogue System** (Patent: 6,626,400)

The 1¾" Kevlar outer bridle extends past the disc all the way to the main deployment bag. The kill line is 1200 lb. Spectra and terminates at the bag. Because the lower ends of both the bridle and the kill line end at the same place, it is impossible to twist one independently of the other. This means no time consuming untwisting of the kill line. This means less wear, and that the kill line can be easily replaced in the field. And because both the bridle and the kill line share the bag lift-off forces if either the bridle or the kill line breaks, deployment still happens more or less normally, and you don't lose your expensive drogue.

### **Main Deployment Bag**

The Sigma Tandem main deployment bag is designed with a continuous loop of tubular nylon at the top of the bag. This prevents canopy damage caused by trapping canopy fabric between a bag's grommet and the canopy attachment point.

### **Reserve Ripcord with Spectra (Patent: 7,837,152)**

The spectra reserve ripcord is manufactured out of a double layer of 1000 lbs spectra, exceeding the strength of a standard ripcord steel cable. The spectra construction offers reduced drag than that created between a housing and metal ripcord cable thus reducing the overall pull forces required to activate the reserve.

### **The Skyhook RSL system (Patent: 7,118,073)**

While a normal RSL automatically pulls the reserve ripcord pin following a breakaway, the Uninsured United Parachute Technologies, LLC Skyhook RSL goes two steps further. It automatically releases the non-RSL riser in case the RSL riser was released prematurely (ensuring your reserve will not deploy with half your main still attached). The Skyhook RSL then uses your departing malfunctioned main canopy as a super pilot chute to deploy your reserve canopy, taking about ½ second from breakaway to line stretch (reserve canopy out of the bag). This is 3 to 4 times faster than a pilot chute can do alone. The Skyhook also causes the reserve bag to leave your back with such speed that it becomes far less likely you will entangle with your main canopy in the case of a spinning malfunction.

### **The 'Collins' Lanyard (Patent: 6,056,242)**

The Sigma Tandem integrates our proven "Collin's Lanyard" System into the yoke. This system automatically releases the other main riser if the RSL-side main riser breaks, or releases prematurely for any reason. This minimizes the possibility of a potentially fatal main/reserve entanglement.

### **Magnetic Riser Covers**

Sigma Magnetic riser covers utilize the most successful design on the market, providing improved security during freefall and contributing to on heading openings as the force to open each riser cover is equal. Years of extensive research and development along with thousands of jumps resulted in this superior design. It is the ultimate in main riser protection.

### **The Student Harness**

The Sigma student harness is designed for comfort while at the same time offering more control on exit and positioning the student's legs forward and upward under canopy. This means fewer students will get sick or pass out under canopy. It also means fewer landing injuries, a greater return and progression rate. The harness includes the "Y Strap" system to ensure students are unable to fall out of the harness when improperly adjusted.

### **Reserve Flap with Pin Check Window**

Depending on the Sigma model selected, there are two versions of the Reserve pin cover. Both allow for pin checks without opening the flap. Sigma uses a removable Lexan window that allows for easy replacement if damaged or worn out. The reserve pin cover on the Micro Sigma is made from clear vinyl.

### **AAD Check Window**

The AAD window is visible so a pin check and AAD condition check can be accomplished at a glance, even while you are wearing the rig.

## CHAPTER 2: APPLICANT INFORMATION

### APPLICANT QUALIFICATIONS

Before an applicant may attend a tandem certification, the following criteria must be met:

- Be at least 18 years of age.
- 3 years of skydiving experience in accordance with FAR 104.45. \*
- Hold a current USPA D license. \*
- Currently possess, or at one time been issued, a USPA Coach, a USPA static-line instructor, or USPA AFF Instructor rating. \*
- Have logged at least 500 ram-air jumps and accumulated at least 6 hours freefall time.
- Has logged at least 30 jumps from above 9500 feet within the preceding 90 days or 100 ram-air jumps in past 12 months.
- Hold a current FAA medical certificate or approved medical equivalent. \*

\*Denotes foreign equivalent acceptable when all documents are from the same country.

**Note:** Each candidate has the responsibility to inspect the credentials of the Tandem Examiner. Certification paperwork, filed by any Tandem Examiner who is not a current Tandem Instructor, will be considered invalid by the Uninsured United Parachute Technologies, LLC.

**BE SURE YOUR TANDEM EXAMINER IS HOLDING A VALID, CURRENT UPT SIGMA TANDEM EXAMINER LICENSE.**

### COURSE REQUIREMENTS

Each candidate is required to bring the following items to a Tandem certification course:

- USPA Expert D license or foreign equivalent-valid.
- Jumpmaster/instructor ratings.
- FAA Medical certificate-valid.
- Logbooks.
- Jumpsuits (slow fall & fast fall).
- Wrist altimeter.
- Helmet & goggles.
- Notepad and pen.
- Certification fee.

If the candidate is going to acquire their USPA TI rating, they will have to fulfill all the requirements from USPA as outlined in the USPA IRM.

### COURSE SCHEDULE & ACTIVITIES

- **Paperwork** Time: 20 Min.  
Fill out the applicant data on the Uninsured United Parachute Technologies, LLC "Tandem Instructor Certification Form" and the Uninsured United Parachute Technologies, LLC "Tandem Training Logbook" with the required information.
- **Course Fee**  
Pay the required course fee to the Tandem Examiner. This fee generally includes: Classroom/theory; ground-training; jump costs for the Tandem Examiner and staff; and the rental of

the gear to be used during the certification. The course fee does not include the candidate's personal jumps or the cost of the experienced student who rides with the candidate during certification.

- **Classroom/Theory** Time: 3-4 Hours

This portion of the course will run approximately four hours. The "Tandem Training Video" will be shown module by module with continued discussion after each module.

- **Ground Training** Time: 2-3 Hours

Ground training covers: Student harness fitting; gear check and donning the Tandem system; hooking up the student; practice climb-outs, controlling the student's movements; exits; throwing the drogue; drogue-fall maneuvers; main canopy deployment; special features of the canopy's toggle system; student canopy control training techniques; landing procedures; and main canopy packing.

- **Certification Jumps**

Each candidate will perform the following certification jumps

- Minimum of 1 solo jump with the Sigma Tandem system or many as necessary to become comfortable the operation of the system.
- Minimum of 1 jump in the student position.
- Minimum of 3 jumps in the instructor position with either the Tandem Examiner or appointed Tandem evaluator.

The record of each certification jump will be logged on the certification form and logbook. The Tandem Examiner will observe/critique the packing of the main canopy, and issue the candidate instructions for the next jump. The Tandem Examiner must be present, on the DZ or in the air, during all certification jumps.

The number of certification jumps that must be made by each candidate during the course will depend entirely on the performance level during the first five jumps. It is up to the Tandem Examiner's discretion as to whether the candidate should make additional jumps to qualify. In some situations, the Tandem Examiner may decide that the candidate must withdraw from the course due to poor performance/skills or bad judgment, etc.

If the candidate is successful and has completed the certification course, the Tandem Examiner will file the necessary paperwork with the Uninsured United Parachute Technologies, LLC. The candidate will retain the Uninsured United Parachute Technologies, LLC Tandem Instructor Training Logbook and continue to log the next five future jumps until the minimum 10 logbook jumps have been completed within a 3-month period. The candidate will then log the remaining probationary jumps (11-25) in their personal logbook.

The Tandem Examiner will inform the Uninsured United Parachute Technologies, LLC of any candidate who fails to complete the course and the reasons for the failure.

## **PROBATION**

The probation period will be in effect for a minimum of 25 jumps. The first 5 jumps are for certification. The remaining 20 jumps are divided into 2 sections, each with its own special guidelines. Refer to the Uninsured United Parachute Technologies, LLC Tandem Training Logbook

for specific guidance.

The logbook, when complete, must be verified by a Tandem Examiner or a UUPT Tandem system owner. If the applicant is a UUPT Tandem system owner, then they must submit to Uninsured United Parachute Technologies, LLC a video of at least 3 of the final 20 probationary jumps along with the training logbook.

The Tandem Instructor must send the logbook and license fee to Uninsured United Parachute Technologies, LLC whereupon an official Tandem Instructor license will be issued.

## CURRENCY REQUIREMENTS

In addition to yearly recertification, Tandem Instructors are expected to maintain currency during the yearly recertification period.

- If any Tandem Instructor during probation has not made a Tandem jump within the last 30 days he must make one solo Tandem and a tandem jump with a current tandem instructor who has been briefed on how to respond to Tandem emergencies.
- If any currently rated Tandem Instructor has not made a Tandem jump in the preceding 90 days, he must make one Tandem jump with an experienced jumper acting as a student before taking a student. The experienced jumper must first be briefed on how to respond to Tandem emergencies.
- If any currently rated Tandem Instructor has not made a Tandem jump within the last 180 days, he or she must complete Recurrency Training before taking a student.

## RECERTIFICATION

Renewal Procedures: Tandem Instructor ratings are encouraged to be renewed every year.

**To apply for renewal, you must have made a minimum of 25 tandem jumps as pilot in command within the preceding 12 months: Reviewed Emergency Procedures (EPs) within the preceding 90 days.** It is mandatory to review the Sigma Standard Operating Procedures (SOPs) and EP's every 90 days, however this information should be reviewed every 30 days.

If you have fulfilled the above requirement, you need to complete the following:

- Have a Tandem Instructor Recertification form verified and signed by either a Uninsured United Parachute Technologies, LLC Sigma Tandem owner or Uninsured United Parachute Technologies, LLC Tandem Examiner.
- Send the form, along with a photocopy of your FAA Medical Certificate (or equivalent) and a photocopy of your USPA Instructional ratings (or equivalent) to uninsured United Parachute Technologies, LLC. A payment link will be sent by email once the application is approved.
- If you have not fulfilled the above requirements, you must take recurrency training

## RECURRENCE TRAINING

Recurrence Training consists of a minimum of one solo jump and one Tandem jump with an experienced jumper acting as a student / passenger. The experienced jumper must first be briefed on how to respond to tandem emergencies. In addition, each experienced skydiver acting as passenger must watch the Sigma Waiver video and fill out a waiver. Passenger emergency handles may be used. During the Tandem jump, the applicant must make a stable exit from at least 7,500ft (2,225m), with drogue deployment within 10 seconds and have an open main canopy by 4,500ft (1,335m). Applicant must demonstrate the ability to control heading during drogue-fall by making at least one 360-degree turn. Applicant must also perform dummy ripcord pulls to all operating handles. Landing must be stand-up (wind permitting) within 150ft (50m) of the target. These two jumps must be witnessed and signed off by an Uninsured United Parachute Technologies, LLC Tandem rig owner or Uninsured United Parachute Technologies, LLC Tandem Examiner. (If you are an owner or a current Tandem Examiner, you cannot sign yourself off).

## FOREIGN TANDEM RATINGS

Foreign tandem ratings alone are not valid in the United States of America. A Foreign National wishing to perform tandem jumps in the USA must possess the original Uninsured United Parachute Technologies, LLC Tandem rating. USPA also offers tandem ratings in conjunction with tandem manufacturers.

**SECTION 2: EQUIPMENT**

CHAPTER 1: DESCRIPTION

CHAPTER 2: OPERATION

CHAPTER 3: RESERVE PACKING & CLOSING

CHAPTER 4: MAIN PACKING & CLOSING



## CHAPTER 1: DESCRIPTION

### HARNESS & CONTAINER



- A. AAD Inspection Window** - Turn AAD on or off through clear window. AAD condition can be checked at a glance. \*This is located under the clear vinyl Reserve Pin Cover on Micro Sigma.
- B. Reserve Pin Inspection** - Lexan window allows pin check at a glance, without opening reserve pin cover flap. \*Micro Sigma have clear vinyl flap.
- C. Magnetic Riser Covers** - Designed for improved security and on heading openings.
- D. Drogue Chute** - Stowed in the Spandura pouch, it uses a plastic ball attached to top for deployment
- E. Primary Drogue Release** - Blue golf ball located at the left, bottom of the main container. A pull of approximately 6" will release drogue.
- F. Secondary Drogue Release** - Orange golf ball located at top of right leg pad. A pull of approximately 6" will release drogue. Ideal location for training students.
- G. Cutaway Handle** - Right hand pull. Soft pillow handle attached firmly in an outboard position on right main lift web. Handle color is green.
- H. Reserve Ripcord Handle** - Left hand pull. Loop handle attached firmly to the left main lift web in an outboard position. Handle color is red.
- I. Main Lift Web Adjustment** - The pulley style harness is adjusted using the 2 piece adapter.
- J. Upper Student Attachment Points** - Two D-rings mounted under the large harness ring on both sides of the upper main lift web.
- K. 3-Ring Release:** Main Canopy Cutaway system.
- L. Lower Student Attachment Points** - Two D-Rings mounted on both sides of the lateral.

## THE STUDENT HARNESS

The Sigma Student Harness was designed for safety and comfort. It safely contains the human body without cutting off normal blood flow. Restricted blood flow may cause students discomfort, to become sick or even pass out. The hip-hugging horizontal back and belt strap combination allows the main lift webs to be positioned and held more toward the front of the upper body. This prevents “squeezing” the upper body and the inside of the upper legs which can cut off blood flow. It also automatically lifts the legs up and forward after opening, putting them in a safer position for landing. The 14 points of adjustment will fit a wide range of body sizes and types giving any tandem student a comfortable experience on their sky dive. However, the harness must still be adjusted securely to fit the student’s body to prevent them from falling out in extreme situations and unusual body positions.

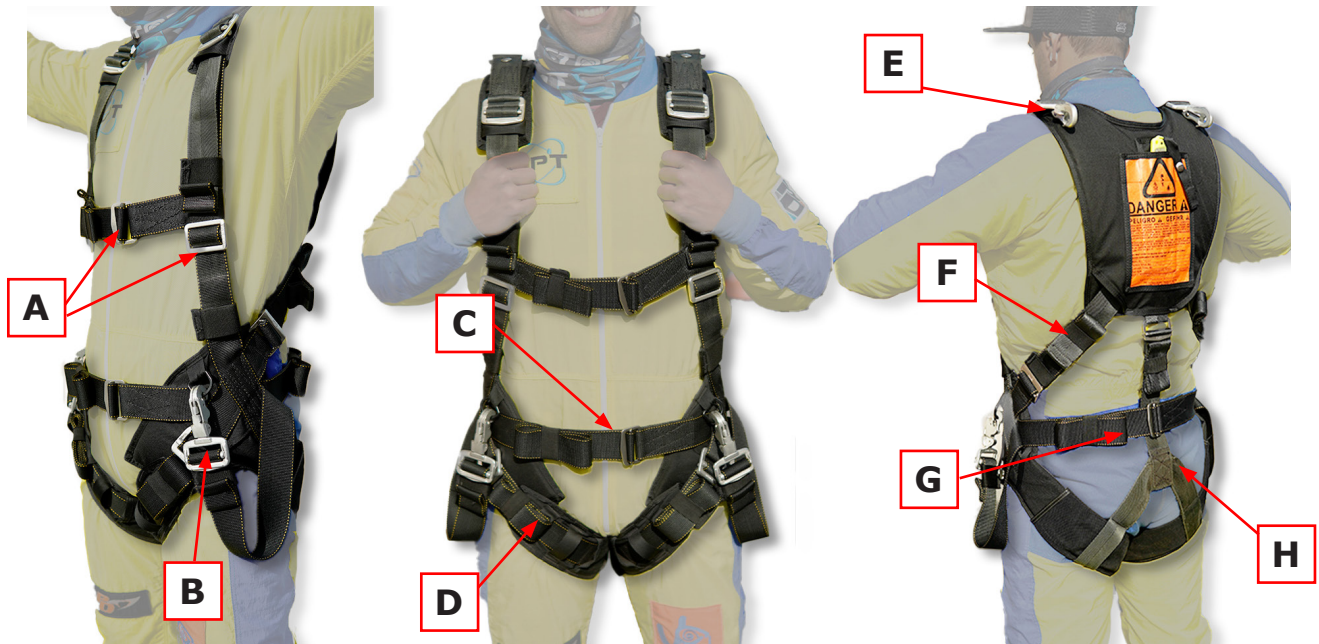

- A. Fully adjustable chest strap.
- B. Side attachment points - Quick ejectors.
- C. Waist band.
- D. Adjustable leg straps.
- E. Top attachment points - Snap hooks.
- F. Diagonal Back strap.
- G. Horizontal Back strap.
- H. Y – strap.

Though there may be different ways in which the order of how the student harness gets put on.

**The student harness must be in jumpable configuration before boarding aircraft!**

## THE SIGMA II MAIN CANOPY

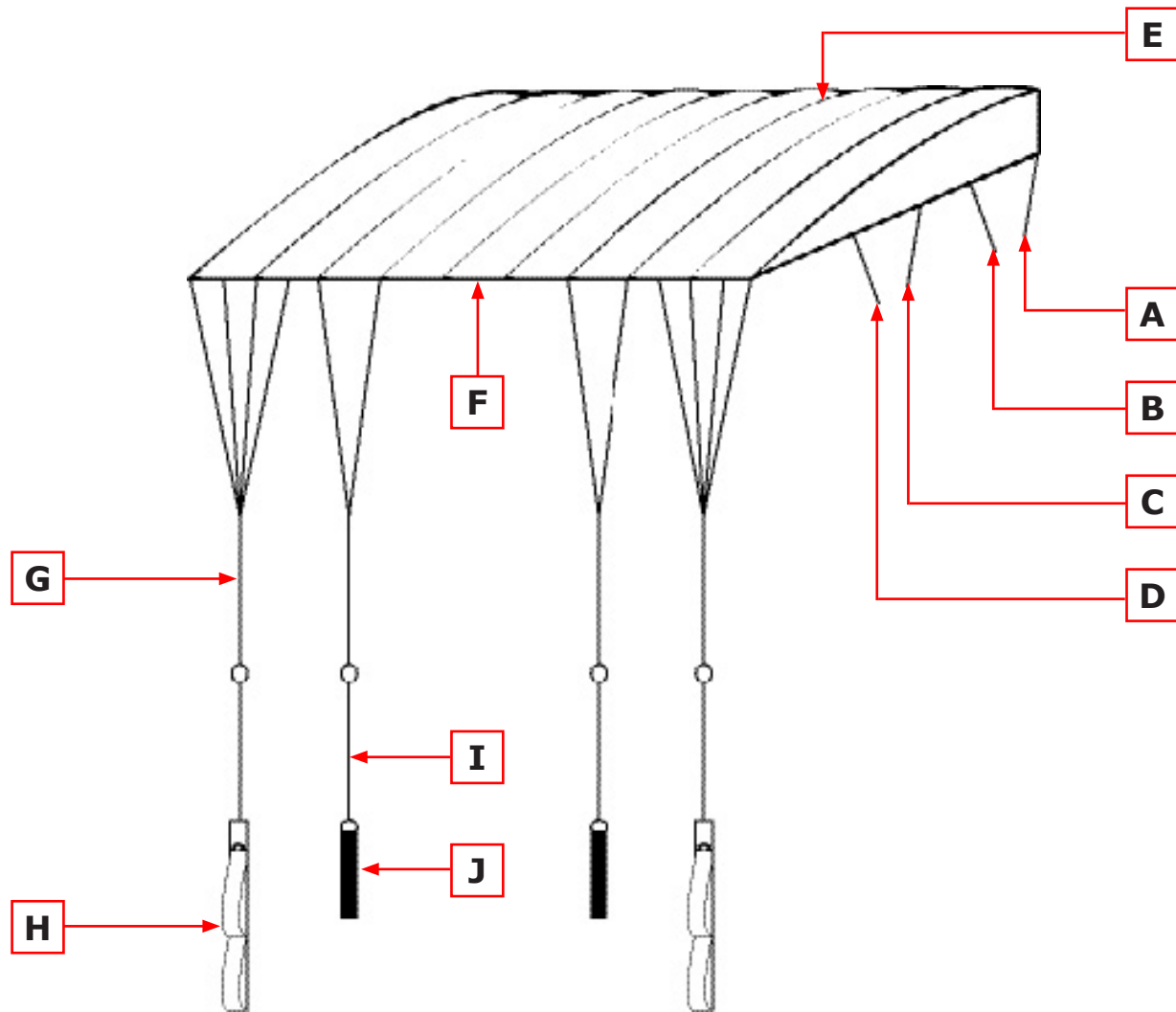

- A. A Line
- B. B Line
- C. C line
- D. D Line
- E. Canopy nose
- F. Canopy Tail
- G. Standard Control Lines
- H. Main Toggles
- I. Secondary control line
- J. Secondary Toggle

## THE DROGUE SYSTEM

The drogue bridle and kill line end at the same place with either a Rapidè link or soft link connected to the top of the deployment bag. When the drogue is set (or cocked) during the packing sequence, the drogue bridle below the disc is "scrunched up", effectively making the bridle shorter than the kill line. When the drogue is deployed, it can inflate because the kill line is longer than the bridle. When a ripcord is pulled to end drogue fall, the container opens and the disc is released, allowing the "scrunched up" section of the bridle below the disc to extend to its full length, thus making the bridle longer than the kill line. This inverts the drogue apex, collapsing the drogue.

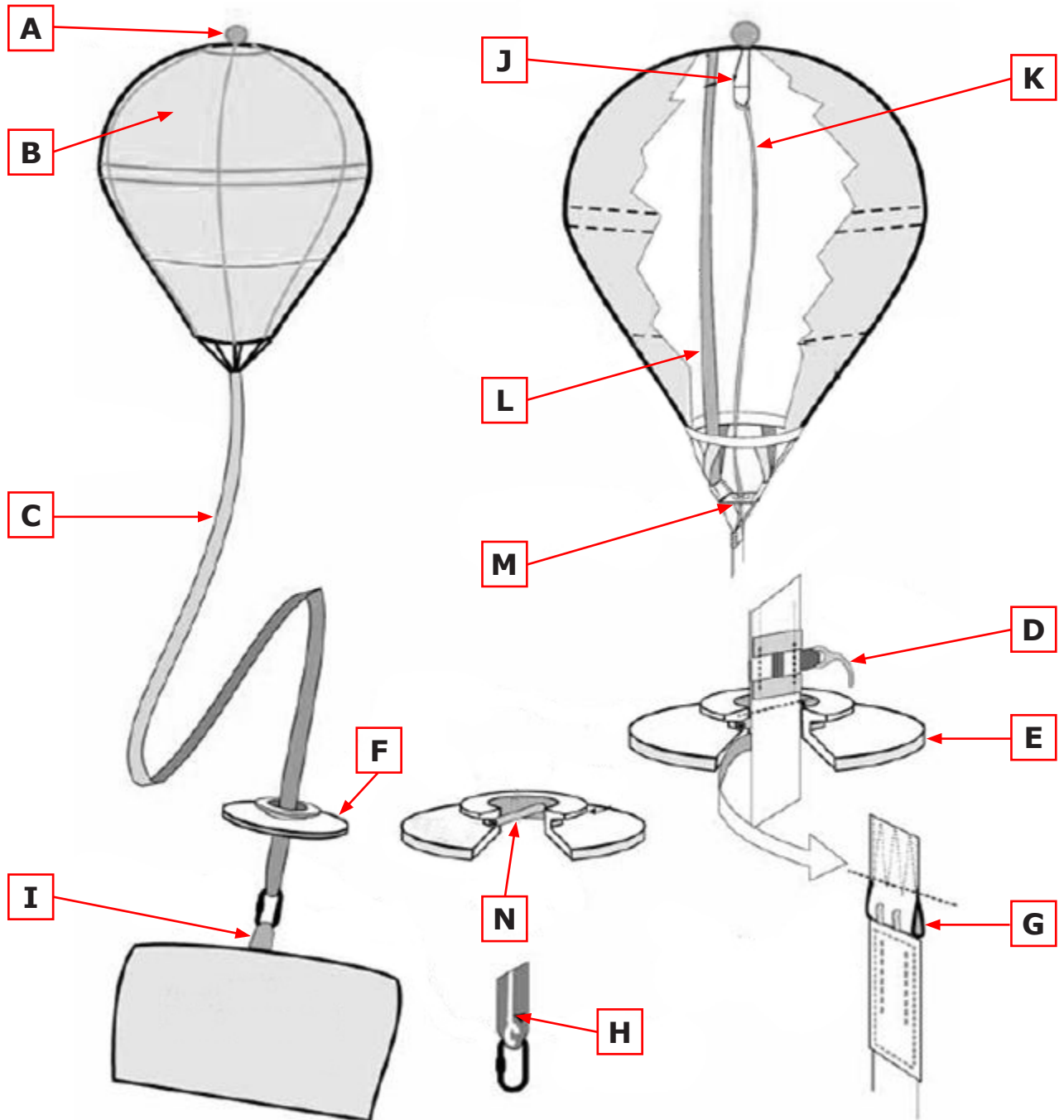

- A. Handle** – The 1-5/8in ball, connected to the apex of the drogue envelope, used to deploy the drogue.
- B. Envelope** – The fabric and mesh portion of the drogue. Its top is called the apex, its bottom the base.
- C. Bridle** – The doubled, 1<sup>3</sup>/<sub>4</sub>”, 2500 lb. Type 12 Nylon or 1500 lb. Type 6 Kevlar section that leads from the envelope to the deployment bag connection loop.
- D. Safety Pin** – A compound-curved pin connected to the bridle, designed to prevent accidental main container openings.
- E. Disc** – A 5” aluminum disc, with a 1 1/2” flanged chimney.
- F. Disc Cover** – Designed to protect disc.
- G. Disc Attachment Loop** - A loop on the drogue bridle to which the disc is attached with a stainless steel pin, held in place with two flat head screws. A 3/32” hex drive is required to tighten or loosen screws.(Enclosed)
- H. Drogue Bridle Loop** – The loop at the end of the Nylon or Kevlar drogue bridle which the deployment bag is attached to.
- I. Bag Attachment Loop** – A loop of tubular Nylon at the top of the main deployment bag where both the bridle and kill line are attached by means of a #5 stainless Rapidè or soft link.
- J. Drogue Centerline Attachment Bridle** – 1” Nylon tape that serves as an attachment point for the kill line, and limits the degree of collapse if a kill line is accidentally made too short.
- K. Drogue Centerline** – A length of 1,250 lb. Spectra line, with a 1” loop at each end, which runs inside the drogue bridle from the kill line attachment bridle to the Rapidè link at the bag attachment loop.
- L. Drogue Set Limiter Tapes** –Two pieces of 1” Nylon tape that run from the drogue apex to the drogue skirt. This saves wear on the drogue bridle and the kill line by limiting the distance they slide on each other during drogue collapse.
- M. Drogue Centerline Guide Grommet** – A “0” stainless steel grommet at the base of the drogue envelope which directs the kill line into the drogue bridle preventing wear. It also serves as an emergency stop for the kill line attachment bridle if the kill line is accidentally made too short.
- N. Disc Attachment Pin** – A threaded stainless steel rod, used to attach the disc to the bridle, using 2, 3/32” hex drive screws.

## THE MAIN RECOIL RIPCORD SYSTEM

The ripcord handles are positioned to allow the tandem instructor to release the drogue with either hand. In addition, the right handle is positioned on the Tandem instructor's harness so as to simulate a Bottom of Container (BOC) position for the student. Once the drogue is released you can simply let go of the handle and it will automatically return to its position on the end of the ripcord housing. The spherical shape of the ripcord handles and their method of attachment makes snagging highly unlikely. If dislodged, they automatically return to position plus the unique "Safety Pin," connected to the drogue bridle, makes it virtually impossible for a snagged ripcord handle to cause an accidental container opening.

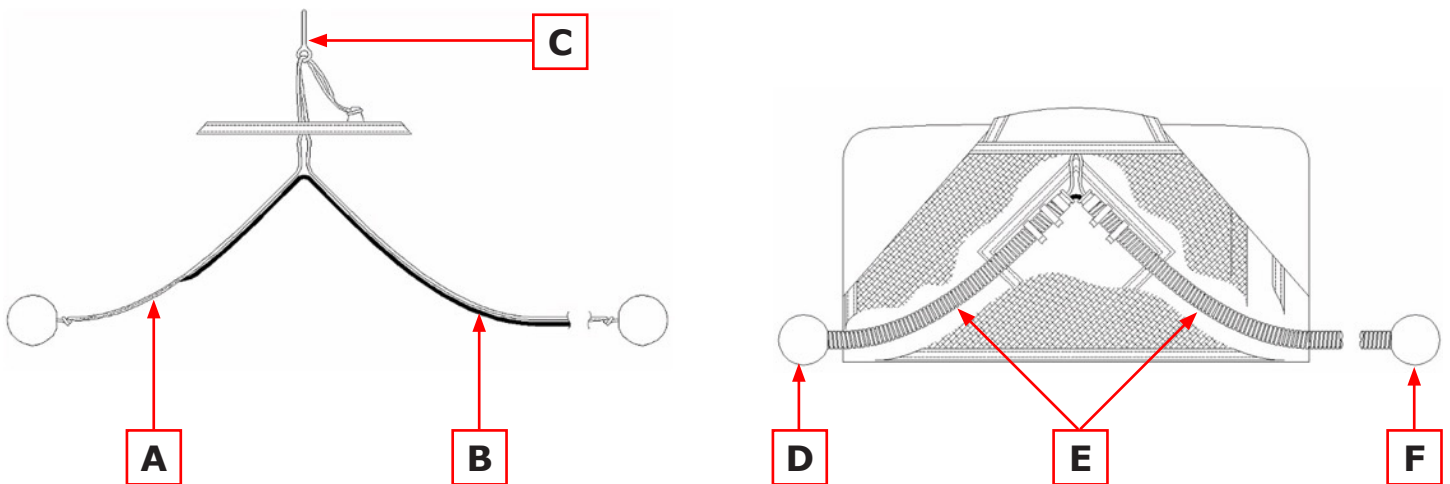

- A. 1000LB Spectra** - A Single Spectra line with finger locked loops at each end, and near the center.
- B. Bungee Cord** - 1/8" bungee cord, finger locked between the loops at each end of the Spectra line.
- C. Main Pin** - One stainless steel, eyeleted, ripcord pin.
- D. Blue Ripcord Handle** - Specially prepared, solid core ball handle.
- E. Ripcord Housings** - Two stainless steel ripcord housings.
- F. Orange Ripcord handle** - Specially prepared, solid core ball handle.

## THE SKYHOOK RSL AND INTEGRATED COLLINS LANYARD

A standard RSL does one thing. It pulls the reserve ripcord pin automatically after a breakaway. The Skyhook RSL with integrated Collins lanyard does this and then goes two steps further. It automatically releases the Left (non-RSL) riser if the right riser releases prematurely for any reason and then uses your departing main canopy as a super pilot chute to get your reserve to line stretch faster than ever before. Breakaway to canopy-out-of-bag times are between  $\frac{1}{2}$  and  $\frac{3}{4}$  of a second, depending on the size of your reserve canopy. This is up to three times faster than a pilot chute can do it alone. If you have a main total malfunction or your AAD fires, the Skyhook Lanyard automatically releases and therefore does nothing to hinder normal reserve deployment.

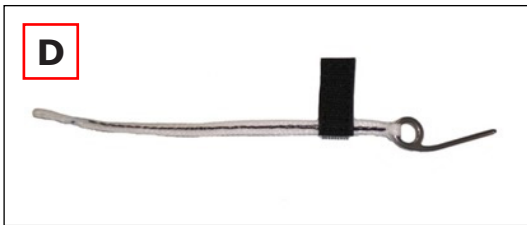
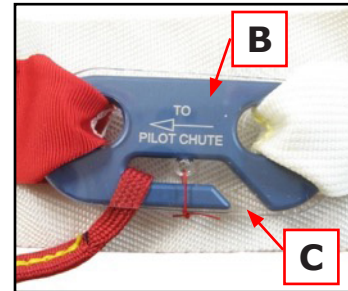

- A. The RSL Lanyard** – Made from 1" black webbing with a snap shackle that connects to your right main riser at one end and splits towards the Collins Lanyard and Skyhook at the other.
- B. The Skyhook** – It is sewn to the reserve pilot chute bridle with red attachment tape indicating direction toward the pilot chute.
- C. Lexan Covers** - One per side. These have small holes drilled in them for safety tie thread.
- D. The Universal Lanyard** - One end is attached to the RSL.
- E. The Red Skyhook Lanyard** - One end attached to the RSL with the other end attached to the Skyhook.

## CHAPTER 2 - OPERATION

### IMPORTANT

The Sigma Tandem is a very different system from a solo sport skydiving system. There are more handles and they are all in different locations. In particular, the reserve and cutaway handles are mounted outboard (otherwise they'd be blocked by the student). Because of this no amount of jumps on solo sport gear will prepare a jumper for the Tandem Sigma. Tandem jumping is stressful and there must be a guide to follow. This is why following procedures is the most important aspect to tandem jumping. Every Tandem Instructor no matter the number of jumps must practice reaching for handles repeatedly on the ground and in the air. It is further required that the Tandem Instructor reach in and touch both drogue release handles, cutaway handle, reserve ripcord handle and RSL during drogue fall on each and every jump. This will help with memorization of exact locations and assist the Tandem Instructor in identifying problems while there is still plenty of time to deal with them. (See fatality reports.) We highly recommend you grab each handle as if you intend to pull it.

### VERTICAL SUSPENDED DRILLS

Due to the differences in the Tandem system compared to a solo system, we highly recommend performing vertical suspended harness drills. Repeating the emergency procedures enough times will ensure that the movements become natural and instinctive. Take note of the different positions of the handles while in a suspended mode. **DO NOT TAKE THIS DRILL LIGHTLY.** If you should ever experience a malfunction, this practice will give you the skills needed to deal with the problem effectively. Contact us for information about custom Vertical Training Systems for Sigma.

### THE SKYHOOK RSL AND INTEGRATED COLLINS LANYARD

The following sections will explain the special operational requirements of key components on the Sigma Tandem System. The components which will be explained are:

- Reserve activation
- Main Activation
- Canopy brakes and steering system
- The Student Harness

### RESERVE ACTIVATION

The cutaway and reserve handles are in different positions and are more securely held in place than on solo rigs. Therefore, it is mandatory that each Tandem Instructor practice several handle disengagements on the ground. Please note that the handles peel away easily in certain directions but are much harder to pull in others.

For an easy pull, the cutaway and reserve handles must be peeled upward and outward and THEN pulled down. This technique **MUST** be practiced on the ground so you will not be surprised in a real emergency.

Perform a thorough emergency drill, locating the cutaway handle and reserve handles, pulling the cutaway and then pulling the reserve handle. Perform this drill enough times to ensure that the movements become a natural reaction.

**NOTE:** It may be helpful to substitute the emergency handles with "mock handles" to be used during practice.



## MAIN ACTIVATION

- **Introduction to the drogue**

Before discussing the procedures for using the drogue, it helps to understand how the drogue functions. The purpose of the drogue is to reduce Tandem freefall velocity, not to aid in stability. When fully inflated, it provides enough drag to give a Tandem pair the terminal velocity of an average solo jumper (120 mph). Without a drogue, a Tandem pair will accelerate in 18 seconds to 170 mph, risking hard opening shocks and canopy damage, as well as making freefall photography difficult. When using the drogue always keep this one point in mind: NO DROGUE - NO MAIN!!!

- **Deploying the Drogue**

- Reach for the handle with palm forward and thumb out.
- With the hand in the same position, take a firm grip on the handle or drogue canopy just below the handle. The force required to extract the drogue can be substantial, especially when the pouch is new, so grip and pull firmly. You may need to place your elbow against the side of the rig and use the leverage gained for added power.
- Deploy the drogue with one continuous motion of the arm: Pull the drogue out aggressively in a sweeping arc, as your arm reaches its fullest extension at shoulder height, throw the drogue at the finish of the arc.
- Turn your head as you are deploying the drogue and watch it inflate. Full inflation takes about 2-3 seconds.

Do NOT hold onto or wave off with the drogue. The bridle is very long and may cause problems if allowed to deploy before the drogue.

- **Familiarization with Drogue Release Handles**

It's important to practice locating and pulling the drogue release handles as they may shift during drogue fall. Start by gearing up and practicing extracting the drogue and pulling the drogue release handle(s). This should be done both in the standing and prone positions. Alternate the use of both the left and right drogue release handles each time you throw the drogue.

## CANOPY BRAKES & STEERING SYSTEM

- **Main Canopy Deployment & Brake Release**

During main canopy opening, reach up and grab the right and left primary toggles only (do not touch the secondary toggles). To release the primary toggles, pull straight back releasing the snap followed by pulling downwards to release the brakes.

- **Double brake system for the Sigma canopy (340,370 & 395)**

The Double Brake System is an innovation in the steering line set up on the Sigma Tandem system that provides reduced toggle pressure and faster turns during normal flight while at the same time producing extra stopping power in low wind conditions. There are six upper control lines on each side of the canopy which are separated and connect to the primary and secondary toggles. For normal flight and turns, only the primary toggles are required. For landing, both the primary and secondary toggles are required.

- **Main Canopy Flight & Landing**

For normal flight, from opening altitude down to no lower than 1000ft (300m), use the primary toggles. In preparation for landing, grasp both the primary and secondary toggles.

- **Toggles familiarization**

Practice by releasing the toggles and brakes as well as reassembling them. Do this with the rig outstretched on the floor as well as with a suspended harness.

## DONNING AND ADJUSTING THE SIGMA TANDEM

The Sigma Tandem is designed so that it fits snugly, yet comfortably, when the harness is properly adjusted. Pick up the Sigma Tandem using the main lift web close to where the 3-Rings are located. Put on your Sigma Tandem in the same way you would put on a coat.

1. Threading the chest strap: The chest strap enters the adjuster from behind (closest to the jumper's chest), around the sliding bar, and back through between the bar and the end of the adjuster. Adjust it so the main lift webs are parallel when the chest strap is tight. Stow the end through the black elastic keeper. An un-stowed running end will cause major slippage. \* **WARNING** Improper threading of the chest strap may result in death. Death has occurred from a skydiver falling out of the harness due to an improperly fastened chest strap.

2. Check the leg straps for twists before threading them. Make sure you route the webbing correctly before tightening them until they are snug. Slide the excess strap through the black elastic keepers provided and then stow the excess strap in the pockets on the leg pads. This will ensure that the leg straps don't flap around in the air while you are in freefall.

**SUMMARY** To summarize the adjustment procedures: • Always check your gear thoroughly before putting it on. • Put the packed rig on over your jumpsuit. • Thread the leg straps through the adapter or connect the straps, checking that they are not twisted, and position the comfort pads. • Tighten the leg straps until snug. • Stand up straight and secure the chest strap; it should not be cinched too tightly.

\* It is common practice for Sigma Tandem Instructors to leave the leg straps properly threaded in between use. Therefore, it is perfectly acceptable to leave the Sigma tandem system leg straps properly threaded before donning. Once the Sigma tandem system has been placed over the shoulders with both arms properly oriented through each side of the system, the Sigma Tandem Instructor may then place each leg through the appropriate loosened leg strap. Once both legs have passed through their respective leg straps, the appropriate webbing tightening (as described above starting with the chest strap) may begin.

## STUDENT HARNESS FITTING & ADJUSTMENT

While fitting this harness on a tandem student is not difficult, the most important point to consider is the security of the student. You must ensure that all straps are tight against the student's body. You may use the following guide to keep your students safe and comfortable.

- Loosen the harness before donning.
- Rotate the harness on the student's shoulders so the Top Attachment Snaps will be easy to hook up.
- Adjust the Horizontal Back Strap so the Main Lift Webs and Leg Straps are positioned as shown.
- Adjust the Horizontal Waist Strap.
- The Horizontal Waist Strap and Horizontal Back Strap should now be tightened firmly around the hips.
- Adjust the Leg Straps
- Adjust the Main Lift Webs and Diagonals so the harness's Hip Junctions are resting squarely on the student's hips.
- Adjust the Chest Strap and slide vertically into the correct position and tighten.
- Adjust the Y- strap.



Notice how the main lift web is positioned more toward the side of the body than it would be on a smaller person. From this position, six straps, going in every direction, totally contain the pelvic area. This containment appears appropriate on this person when the Main Lift Webs are further apart.

It's recommended to hook up and suspend your student so the harness conforms to the student's body. Release the student and check all adjustment points. You may find it necessary to tighten the harness a bit more. The Horizontal Back Strap must be positioned low on the back and securely tightened. On anyone with a larger body frame the Main Lift Webs should be positioned further apart than on a smaller person. The harness has 14 points of adjustments. Use them to completely surround and contain the student's body.

## STUDENT HARNESS ATTACHMENT PROCEDURE

- Left Side Lateral Connection: Ensure that the lateral strap is not twisted and the quick ejector is seated all the way down on the detent.
- Right Side Lateral Connection: Ensure that the lateral strap is not twisted and the quick ejector is seated all the way down on the detent.
- Top Right Snap Hook: Ensure that the Snap Hook is completely secured around the attachment ring.
- Top Left Snap Hook: Ensure that the Snap Hook is completely secured around the attachment ring.
- Depending on the aircraft that you are jumping from may dictate when the side laterals are tightened. Once the hook up procedure is completed, you should have all four attachment points hooked up with the appropriate tightness of the Lateral connection points.

## CHAPTER 3 – RESERVE PACKING & CLOSING

### INSTALLATION OF AAD

Approved Automatic Activation Devices:

- Vigil, Vigil 2, Vigil 2+, Vigil Cuatro
- Cypres 2 (Original Cypres units have “timed out” and are no longer acceptable for use.)
- M2



Ensure AAD is either dedicated TANDEM, or in TANDEM mode if using a multi-mode AAD, before installing into container.



Insert the AAD unit into the pocket. Ensure that cable connections lay flat towards the side wall, or the convex curve is towards the side wall.



Route AAD cutter cable through channel, and loop any excess cable into the AAD pouch.

Place AAD cutter into elastic keeper

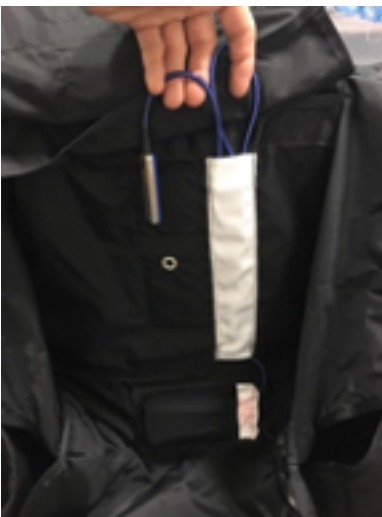

Route control unit cable through white sleeve, and loop any excess cable into sleeve and/or AAD pocket.

Pass the control unit through slit inside the top of the sleeve.



**SIGMA ONLY:**

Pass control unit through slit in the yoke.

**SIGMA ONLY:**

Place control unit into AAD window pocket.

Avoid tension or excessive slack on cable.

**MICRO SIGMA ONLY:**

Route control unit across back pad, underneath #6 flap.

**MICRO SIGMA ONLY:**

Route control unit behind reserve housing, and insert into AAD window pocket with display visible upwards.

Avoid tension or excessive slack on cable.

## SIGMA 2 RESERVE CANOPY INSPECTION

The Sigma 2 reserve canopy is a 9-cell F111 canopy, with cascaded Vectran lines. The Sigma 2 reserve must be inspected thoroughly before it is packed the first time and at each repack. This inspection should be performed with even more care and attention when first assembled and after a deployment. A certificated rigger must inspect your new Sigma 2 reserve and determine its compatibility with your rig.

This inspection should be done in a clean, well-lit area with enough room to spread out the reserve canopy.

Here is the Uninsured United Parachute Technologies recommended procedure for inspecting your reserve canopy.



Thoroughly inspect every part of the canopy

- The reserve ripcord
- Pilot chute and bridle
- Deployment bag
- Lines
- Links
- Risers
- Harness & Container
- Closing loops

## RECOMMENDED TOOLS

The following is a list of recommended tools you may need:

- Adjustable crescent wrench for number 6 stainless steel links
- Scissors & snips
- Pull-up cord
- Velcro fastener strips with flags (2 short or 1 long pile)
- Locking soft bodkin
- Metal bodkin/T-bar
- Temporary pin with flag.
- Seal, seal press & seal thread
- Link Separator
- 2 packing Paddles
- Weight bags
- 4 clamps (ensure smooth tips and no sharp edges)
- Cranking/positive leverage devices and knee plate

## ASSEMBLY OF RESERVE CONTAINER COMPONENTS.

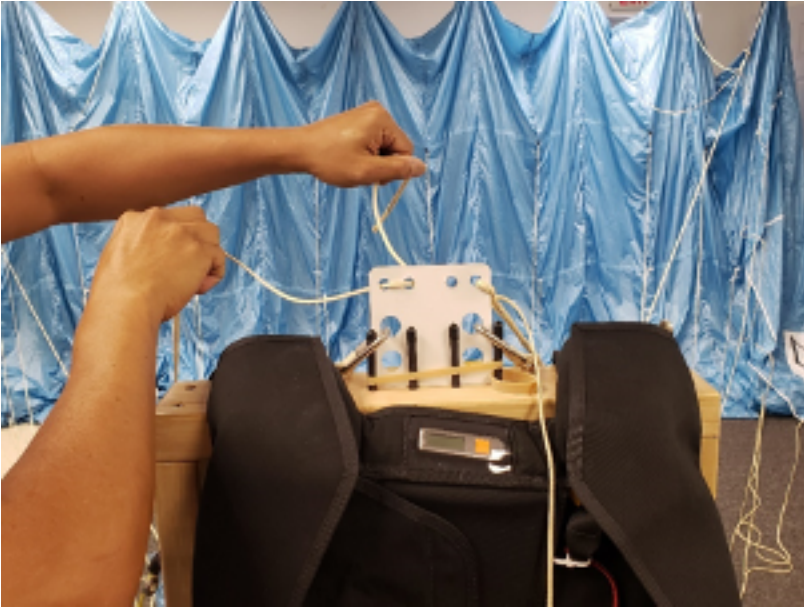

### **SIGMA 2 RESERVE (Using #6 rapide links)**

Place Sigma 2 reserve canopy and container in correct orientation relative to each other

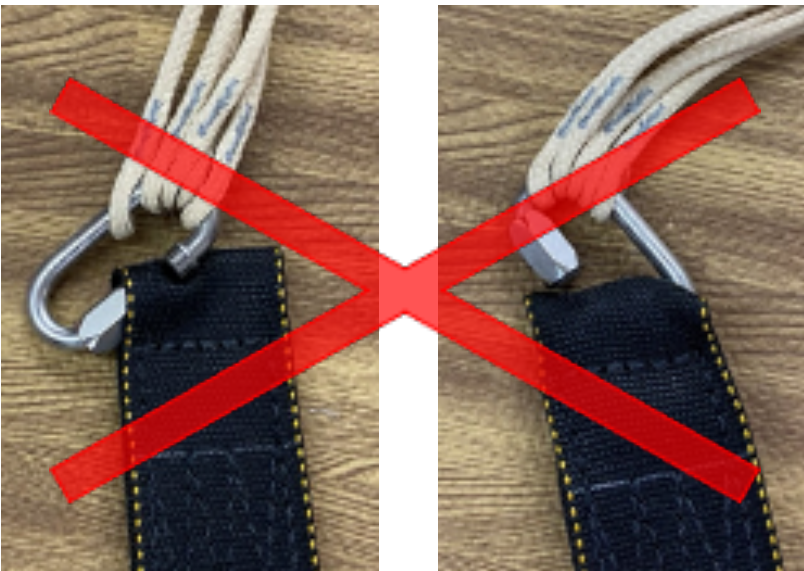

**Note: DO NOT** assemble this parachute on to riser that have the smaller L-Bar style attachment loops.

Previous tandem reserve models used continuous suspension lines that required L-Bar connectors. This reserve parachute is certified for use with #6 stainless steel rapide links only. Assure that the reserve risers of the harness/container system that this parachute is to be installed on can properly accommodate the supplied #6 stainless rapide links.



**\*SIGMA 2 RESERVE INSTALLATION (Using #6 rapide Links) REQUIRES THE REMOVAL OF THE 5 CORD BOXING AND THE TYPE 12 BUFFER ON THE RESERVE RISERS.**

Draw a line at the top of the reserve riser four point.

Only remove stitching up to this point



Remove only the stitching indicated in red, making sure to avoid damaging the webbing.

\*It should be noted that the 4-point stitch pattern must stay intact/verified after the completion of the modification.

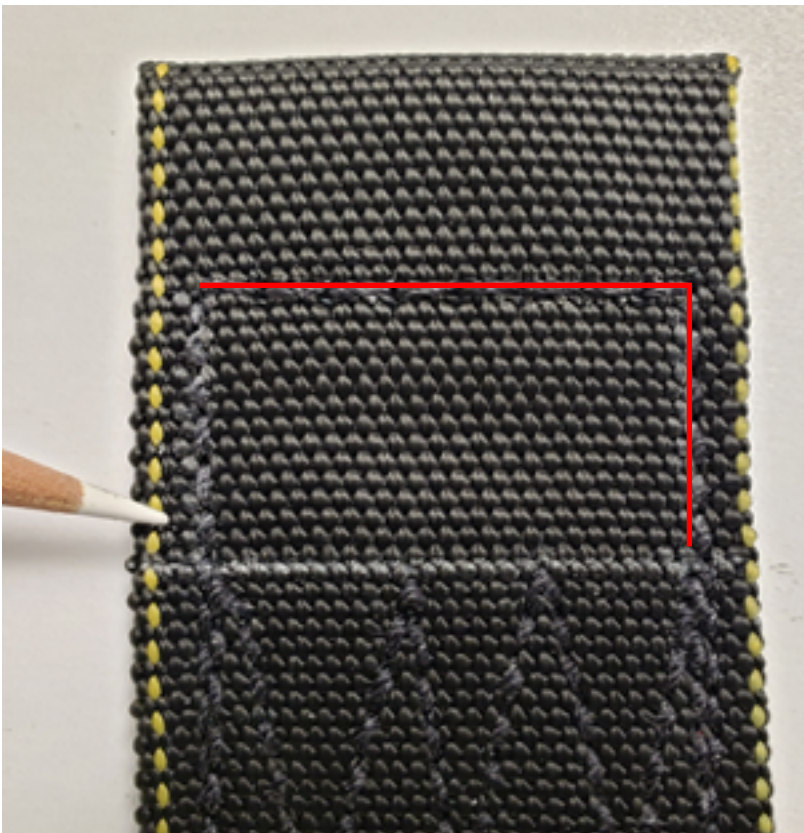

\*Detail of 5 cord stitching removal

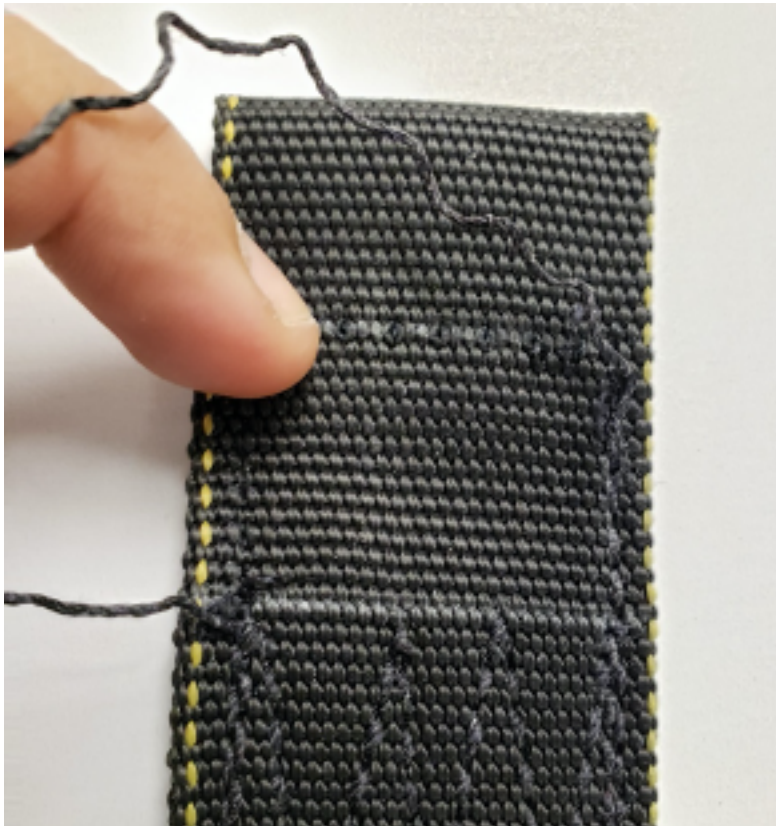

With stitching removed the Type 12 buffer can be eliminated.



## LINE BUMPER INSTALLATION



Place pull up chord around rapide link and slide through link protector.

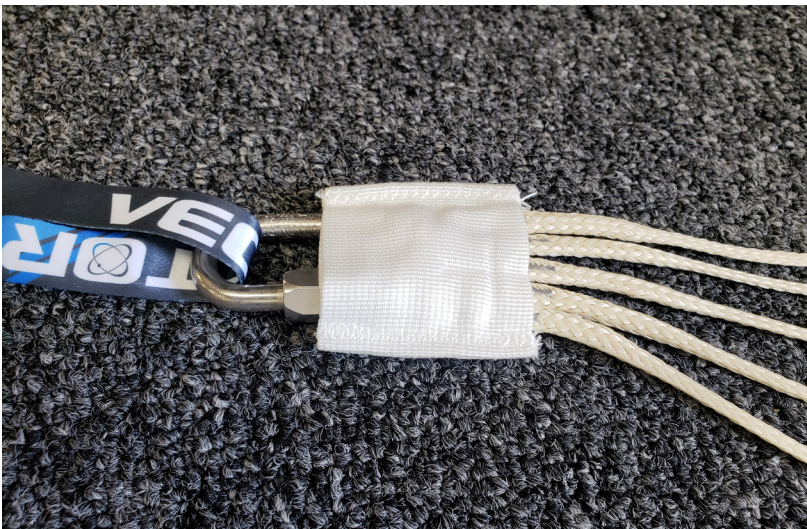

Continue to slide link protector up and over rapide link.



Place and pair reserve riser with correct line group, provided link protectors and number 6 links

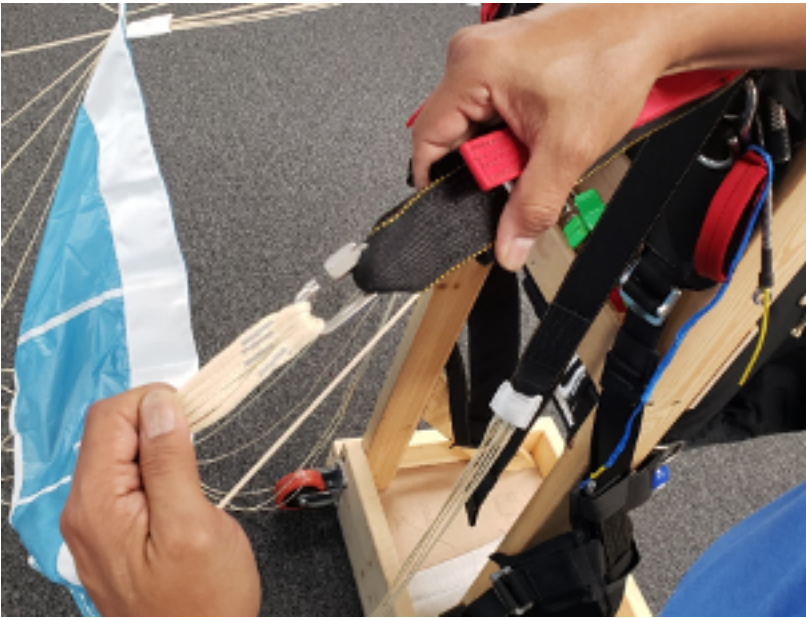

Attach with #6 stainless steel rapide links with barrel facing inboard, ensuring correct continuity of lines.



Finger tighten the # 6 link barrel.



Set and tighten the # 6 link with appropriate wrench.

\*Tighten finger tight, and torque to 20 inch / lbs (1.22927 N.m). Do not tighten more than 30 inch / lbs (1.8439 N.m).



Slide link protector over link and hand tack in place.

Repeat for remaining risers/ Lines groups.



Thread the end of the steering line through the guide ring.



Thread the end of the steering line through the toggle grommet.



Continue to thread the end of the steering line through the toggle grommet.



Loop the end of the steering line over the toggle.

**VR360 VTC-II (L BAR INSTALLATION)**

Place VR360 and container in correct orientation relative to each other.



Place and pair reserve riser with correct line group and L-bar.



Remove screws and open L-bar using separator tool.



Attach L-bar to reserve riser, ensuring correct continuity of lines.



Hand set the L-bar. Outboard screw placement must be at the top.

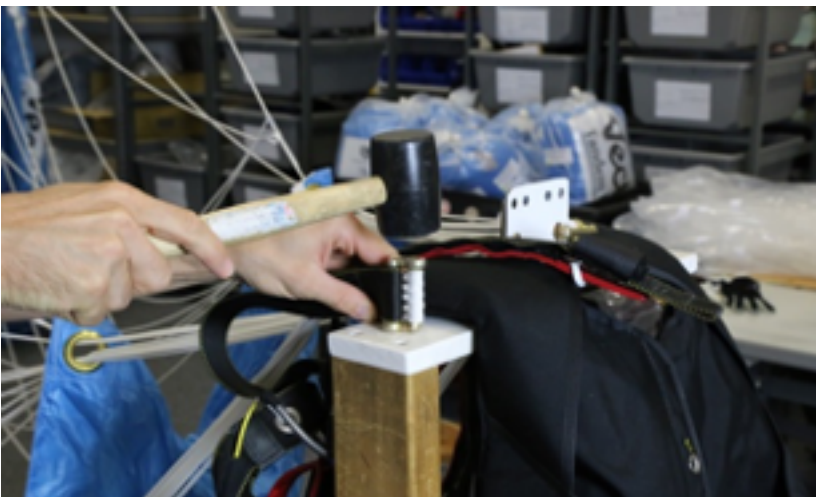

Set L-bar completely with rubber mallet, on a protective surface.





Insert and tighten screws completely, without excessive force. Ensure that L-bar is completely set by alternating while tightening.

Repeat for remaining risers/L-bars.

## SETTING RESERVE BRAKES SIGMA 2 RESERVE



Route Dacron loop on riser through lower brake line cat's eye.



Route Dacron loop through guide ring.



Insert toggle end through Dacron loop, with excess brake line towards thin inside of the container.



Place toggle onto Velcro and snap in place.



Route excess control line back and forth next to guide ring.

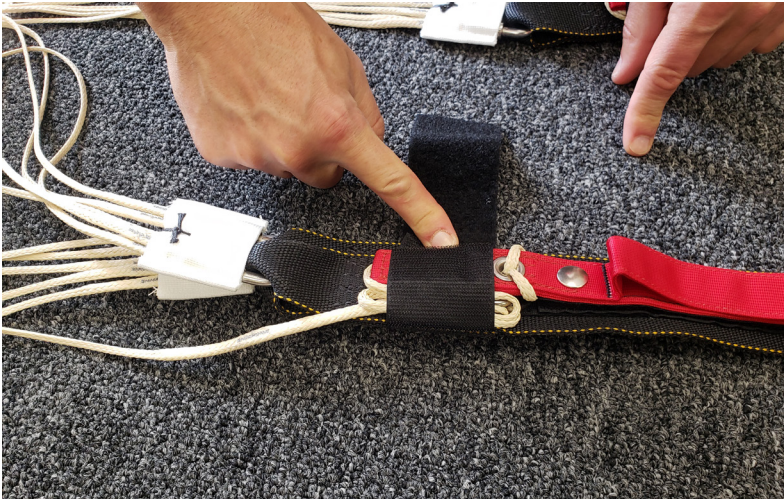

Place hook side of Velcro over S-Folded brake line and toggle tip.



Cover control line with Velcro, and mate to secure in place.

Do not trim excess pile Velcro

## SETTING RESERVE BRAKES VR360/VTCII



Route Dacron loop through lower brake line cat's eye.



Route Dacron loop through guide ring.



Insert toggle end through Dacron loop, with excess brake line placed away from container.



Place toggle onto Velcro and snap in place.



Route excess control line back and forth next to guide ring.



Cover control line with Velcro, and mate to secure in place.

Do not trim excess pile Velcro

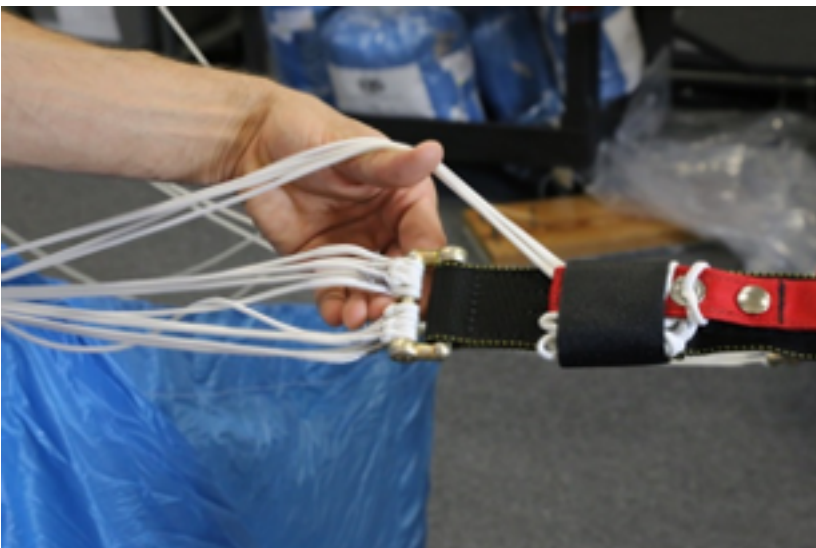

Spread the lines on the rear risers evenly to reveal the L-bar



Tie control lines onto the L-bar using a double layer of seal thread.

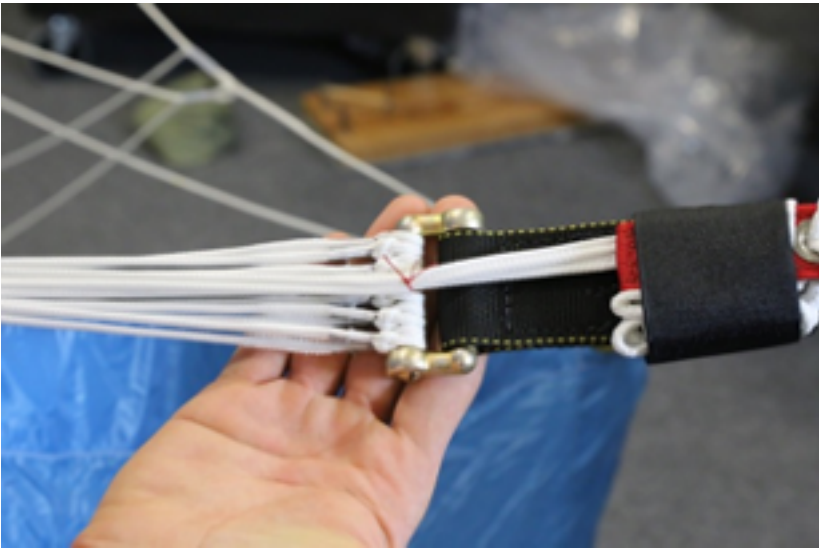

Finish with a riggers knot.  
Repeat for opposite side.



Route bridle through 3 Dacron line loops on reserve pilot chute



Route bridle and bag through loop end of bridle.



Tighten up lark's head knot evenly.



Place RSL onto Velcro, with pin in the pocket.



Close the Velcro cover.



Route breakaway cables through the 2 first housings, and secure handle in Velcro.



Route breakaway cable through Collins Lanyard, then through second housing.





Exit the cable from the housing.



Position and secure the white Universal lanyard using the Velcro tab.



Route reserve cable through housing, and secure handle in Velcro.

Ensure that break away housing is separate from reserve cable and housing.

## PACKING RESERVE CANOPY-VR360/VTCII



Prior to packing, inspect canopy for any damage, and ensure correct line continuity. Ensure control lines are tied to L-bars.

Grab individual line groups and follow lines up to the slider. The line groups must be clear up to the canopy, and pass through the slider grommets.



Place canopy over shoulder, and flake the nose counting each cell. When you have the entire nose flaked, tuck it between your knees and hold it there. Clear the stabilizers. Flake each side outwards, with lines and line attachment points placed in center. Quarter the slider. Clear the tail, flake the material between each steering line outwards, with lines and line attachment points placed in center



Spread the nose of the canopy with an even number of cells to the left and the right, leaving the center cell fully exposed in the middle.



Hold the lines in one hand with tension forward, and use your free arm to support the canopy fabric while gently placing the canopy on the packing surface.



Place a packing weight at the base of the canopy, and maintain line tension. Dress up the canopy folds from flaking, keeping the lines centered.



Starting at one side of the canopy, carefully lift the folds of material back towards the center of the pack job until the nose is exposed. Use packing weights hold the opposite side in place. Flake the 4 nose cells to the outside, and lay them flat. Use a packing weight to hold them in place.



Flake the material between the A and B lines away from the line channel in the center of the pack job. Be sure to have A and B line attachment points and their reinforcement tapes in the center of the pack, stacked together. Even up the bottom seams at the stabilizer.



Smooth out the fold between the A and B lines, and create a reduction fold in half towards the center of the pack job. Go to, but do not go beyond the line attachment points. Use weights to control the fabric and folds.



Repeat the previous steps to flake the material between the B and C lines. Repeat the previous steps to flake the material between the C and D lines.



Flake the material between the upper control lines toward the outside of the pack job leaving the control lines stacked neatly on the top of the A, B, C, and D lines from before.



Move to the opposite side and repeat the steps for nose, A/B/C/D, and tail. Dress up and quarter the slider into the folds of B and C, without exposing too much on the front or back. Make sure the line channel in the center of the pack job is clear, and all lines and attachment points are in the center of the pack.



Fold the flaked tail section of the canopy under to achieve the same width as the rest of the canopy folds. Prepare the center cell material to cocoon the canopy, without distributing the folds.



Use the center cell material to cocoon around the tail section.



Place this in between the A/B folds and B/C folds, effectively cocooning the fabric from C lines until the tail.



Ensure that all folds are the same width, and use packing weights to hold in place. The center cell seam should be centered on the pack.



Count the 4 cells of the nose and grab them while maintaining tension forward.



Roll the 4 cells together downward and in until equal with, and placed under, the edge folds. The roll should not be aggressive, but similar to very narrow folds.



When the nose folds are complete, the leading edge should be even with the edge of the cocooned canopy.



Repeat for opposite side



Prepare the reserve bag to receive the canopy.

**The VR360 tandem reserve parachute is compatible with both the original VR360 Reserve deployment bag as well as BOTH sizes of the new "TB Reserve Deployment Bag" (Micro Sigma/SR340 TB bag and Sigma/SR370 TB bag).**





Insert the locking pull-up cord into the center grommets, and allow approx. 1" distance between grommets.



The dressed width of the canopy should be 1 inch wider than the width of the reserve pack tray to allow it to fill the free bag completely.



Perform the first S-fold, while controlling the slider grommets and line tension. Using packing paddles will greatly help this.



Once first S-fold is complete, the slider grommets should be placed approx. 1" behind fold line.



Press down and hold tension on lines and slider grommets in place.



Prepare the reserve bag to receive the canopy.



Ensure that nose folds are still rolled up, and placed close to center. Dress center cell to the width of the pack job, covering the nose folds on each side.



Place the reserve bag in position above, and slightly underneath, the canopy.

**The SR340 & SR370 tandem reserve parachutes are ONLY COMPATIBLE with the appropriately sized new TB Reserve Deployment Bag.**

Container	VR-360	SR-340	SR-370
Micro Sigma (S12)	Micro Sigma Reserver bag S12 TB Reserve Bag	S12 TB Reserve Bag	S12 TB Reserve Bag
Sigma (S13)	Sigma Reserve Bag S13 TB Reserve bag	NOT RECOMMENDED	S13 TB Reserve Bag



Use a packing paddle to establish the fold line for the remaining S-fold.



Use a packing paddle to establish the fold line for the remaining S-fold.



Place knees to control pack and S-folds, and remove packing paddles.



Follow the center seam to split the remaining part of the canopy into 2 ears. Spread the fabric and not roll fabric in front of the leading edge.



Pull pack the ear to make the first half dense, and scrunch up the second half for a softer feel.



Insert ear into the reserve bag, repeating the steps for the opposite side of the canopy. Switching from side to side, move the entire canopy gradually into the freebag.



Use a needle fold of bridling material to secure one end of the safety stow allowing you make the first locking stow.



Both locking stows should contain a line bight 3" long.



Dress the pack job to the finished shape desired. The bagged canopy should reflect the desired shape of the rig for best results. It should be square at the bottom, wedge shaped in profile, and thin at the top. When pressing down on the pack job, it should be firm at the mouth of the bag and get progressively softer as you get closer to the bridle attachment point. 1" to 2" of canopy material protruding from the mouth of the bag will help fill the reserve container corners.



Place two Velcro protectors on the line stow pouch, or a single across holding the lines in place, and ensure an open line pouch.



Stow the remainder of the suspension lines into the pouch on the underside of the bag using S-folds that extend completely from one side of the pouch to the other. Remove the two Velcro protectors from the bag and mate the Velcro. Be sure none of the lines are trapped between the hook and loop fastener at the mouth of the pouch.



Create a slight indentation in the center of the pack job to accommodate room for the AAD unit.

## PACKING THE SIGMA 2 RESERVE CANOPY



Prior to packing, inspect canopy for any damage, and ensure correct line continuity.

Grab individual line groups and follow lines up to the slider. The line groups must be clear up to the canopy, and pass through the slider grommets.



Place canopy over shoulder, and flake the nose counting each cell. When you have the entire nose flaked, tuck it between your knees and hold it there. Clear the stabilizers. Flake each side outwards, with lines and line attachment points placed in center. Quarter the slider. Clear the tail, flake the material between each steering line outwards, with lines and line attachment points placed in center.





Spread the nose of the canopy with an even number of cells to the left and the right, leaving the center cell fully exposed in the middle.



Hold the lines in one hand with tension forward, and use your free arm to support the canopy fabric while gently placing the canopy on the packing surface.



Place a packing weight at the base of the canopy, and maintain line tension. Dress up the canopy folds from flaking, keeping the lines centered



Starting at one side of the canopy, carefully lift the folds of material back towards the center of the pack job until the nose is exposed. Use packing weights hold the opposite side in place. Flake the 4 nose cells to the outside, and lay them flat. Use a packing weight to hold them in place.



Flake the material between the A and B lines away from the line channel in the center of the pack job. Be sure to have A and B line attachment points and their reinforcement tapes in the center of the pack, stacked together. Even up the bottom seams at the stabilizer.



Smooth out the fold between the A and B lines, and create a reduction fold in half towards the center of the pack job. Go to, but do not go beyond the line attachment points. Use weights to control the fabric and folds.



Repeat the previous steps to flake the material between the B and C lines. Repeat the previous steps to flake the material between the C and D lines.



Flake the material between the upper control lines toward the outside of the pack job leaving the control lines stacked neatly on the top of the A, B, C, and D lines from before.



Move to the opposite side and repeat the steps for nose, A/B/C/D, and tail. Dress up and quarter the slider into the folds of B and C, without exposing too much on the front or back. Make sure the line channel in the center of the pack job is clear, and all lines and attachment points are in the center of the pack.



Fold the flaked tail section of the canopy under to achieve the same width as the rest of the canopy folds. Prepare the center cell material to cocoon the canopy, without distributing the folds.



Use the center cell material to cocoon around the tail section.



Place this in between the A/B folds and B/C folds, effectively cocooning the fabric from C lines until the tail.

Ensure that all folds are the same width, and use packing weights to hold in place. The center cell seam should be centered on the pack.



Count the 4 cells of the nose and grab them while maintaining tension forward.



Roll the 4 cells together downward and in until equal with, and placed under, the edge folds. The roll should not be aggressive, but similar to very narrow folds.



When the nose folds are complete, the leading edge should be even with the edge of the cocooned canopy.



Repeat for opposite side

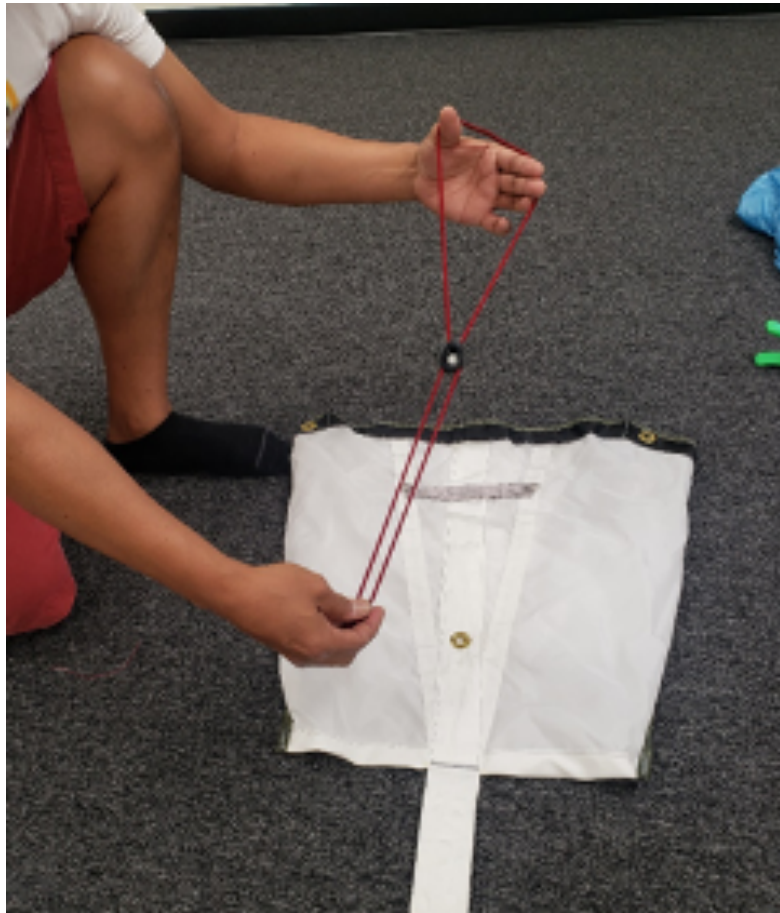

Prepare the reserve bag to receive the canopy.

**The SR340 & SR370 tandem reserve parachutes are ONLY COMPATIBLE with the appropriately sized new TB Reserve Deployment Bag.**

Container	VR-360	SR-340	SR-370
Micro Sigma (S12)	Micro Sigma Reserver bag S12 TB Reserve Bag	S12 TB Reserve Bag	S12 TB Reserve Bag
Sigma (S13)	Sigma Reserve Bag S13 TB Reserve bag	NOT RECOMMENDED	S13 TB Reserve Bag



Insert the locking pull-up cord into the center grommets, and allow approx. 1" distance between grommets.



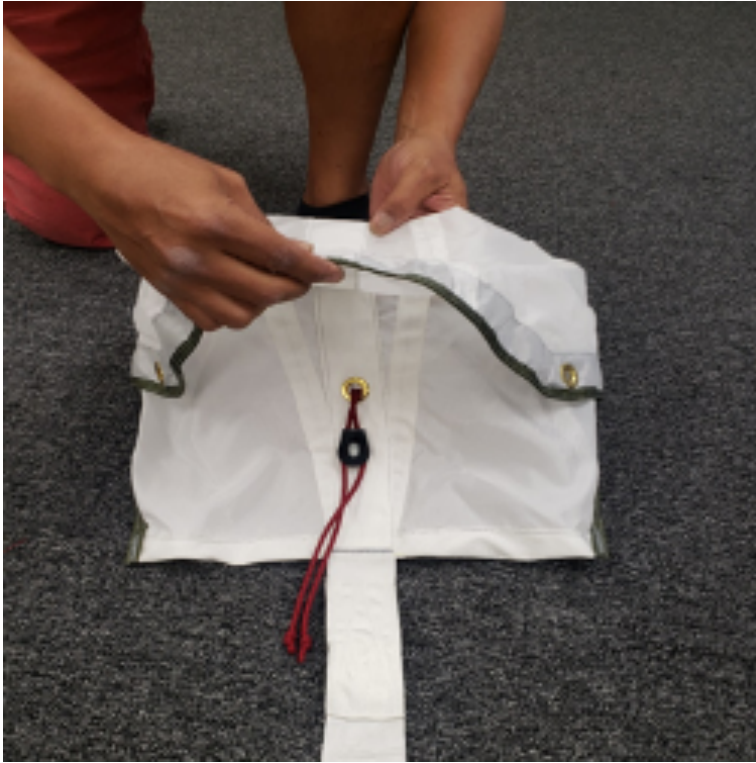

Roll mouth of freebag bag to the freestow channel to allow ease of canopy placement.



Perform the first S-fold, while controlling the slider grommets and line tension. Using packing paddles will greatly help this.



Once first S-fold is complete, the slider grommets should be placed approx. 1" behind fold line.



Press down and hold tension on lines and slider grommets in place.



Reach under cocooned canopy to fold over second S-fold.



Ensure that nose folds are still rolled up, and placed close to center. Dress center cell to the width of the pack job, covering the nose folds on each side.



Place the reserve bag in position above, and slightly underneath, the canopy.



Use a packing paddle to establish the fold line for the remaining S-fold.



Use a packing paddle to establish the fold line for the remaining S-fold.



Place knees to control pack and S-folds, and remove packing paddles.



Follow the center seam to split the remaining part of the canopy into 2 ears. Spread the fabric and not roll fabric in front of the leading edge.



Pull back the ear to make the first half dense, and scrunch up the second half for a softer feel.



Insert ear into the reserve bag, repeating the steps for the opposite side of the canopy. Switching from side to side, move the entire canopy gradually into the freebag.



Use a needle fold of bridle material to secure one end of the safety stow allowing you make the first locking stow.



Route locking stows through the grommet on the side of the bag passing through the inside of the grommet.



Tuck side flap of bag inwards neatly enclosing the corner of the canopy. Bring locking stow through the remaining flap



Dress the corners of the reserve deployment bag by smoothing the edges of the bag with your hand.



Make first locking stow and shape reserve bag side flap to make a clean corner.



Repeat steps on the remaining side of freebag, locking stows should be equal in length and corner of freebag should be tucked inwards forming a clean corner.



Open line stow pouch by separating Velcro tabs on both sides.



Stow the remainder of the suspension lines into the pouch on the underside of the bag using S-folds that extend completely from one side of the pouch to the other. Close the two Velcro tabs mating. Be sure none of the lines are trapped between the hook and loop fastener at the mouth of the pouch.



Place the risers to the sides of the reserve tray with the ends fanned to reduce bulk. Insert a pull-up cord in the reserve closing loop.





Route the pull-up cord through the reserve bag from the bottom and out of the top, using the soft bodkin.



Pull the reserve closing loop through the reserve bag and secure with a temp pin. Ensure that no canopy Material has pulled through the grommet.



Place the AAD into the indentation, and place the lower corners of the reserve pack job into the reserve container.



Thread the pull-up cord through the AAD cutter before passing through flap #1 bottom kicker flap.



Evaluate the length of your closing loop by the following method: Press the #1 flap firmly down while pulling with adequate force on the pull-up cord. The top of the closing loop should extend beyond the bound edge of flap #1 by 1/4". This will help ensure the proper length closing loop is being used.



Secure flap #1 with temp pin. Fold the bridle vertically along both sides of the center grommet, until 6" before the Skyhook, and place these folds under flap #1.

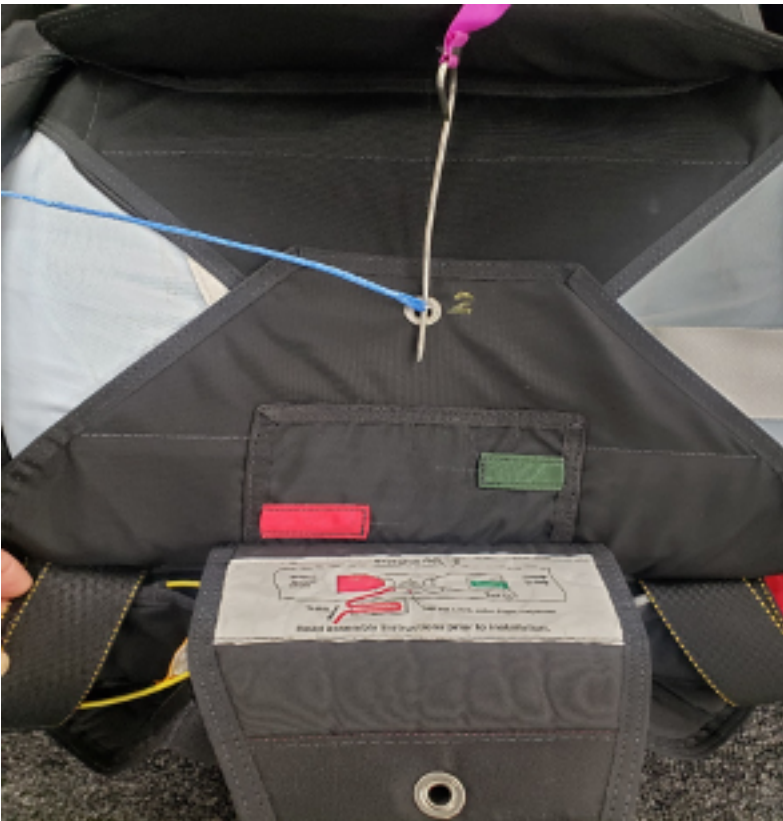

Close flap #2, and secure with the reserve closing loop and temporary pin. Make sure the remaining bridle exits the closed kicker on the side with the green pocket. Note the green "flex tab" on the bridle.

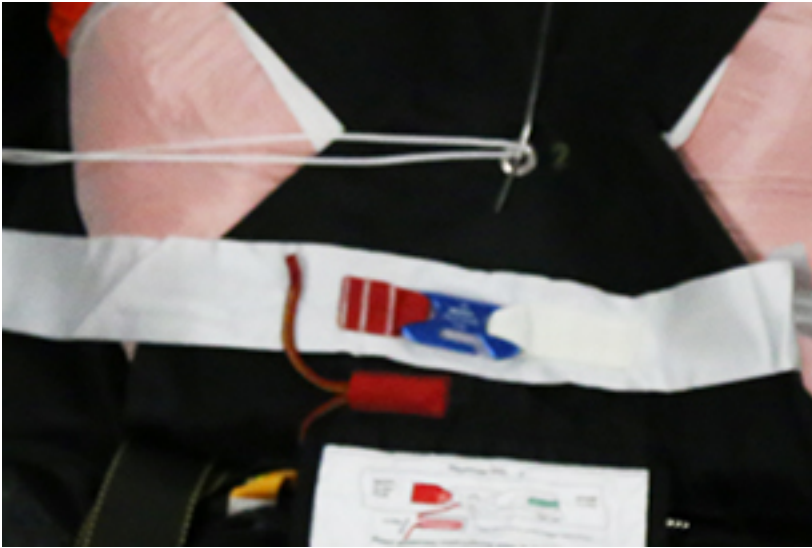

Place green flex tab in pocket and place Skyhook flat across #2 flap. Place the red Skyhook lanyard in the pocket, by folding the stiffened section of the lanyard in half, and inserting it completely.



Attach the red Skyhook lanyard to the Skyhook, and ensure there is no tension, and no slack either.



Insert, and tie, a single thread of 4.75lb safety/seal thread using a "rigger's" knot, to keep the red Skyhook lanyard secure in place.



Close #2A flap and insert temp pin to hold in place.



Fold the bridle to run parallel to the side of the #2A flap, and place underneath the flap.



Stow the remaining bridle on top of the #1 flap, either up/down or left/right, depending on preferred bulk distribution.



Using a gun rod, route the pull up cord straight through the reserve pilot chute without catching any fabric.



Place the reserve pilot chute on top of the bridle, with the center grommets place directly on top of the #2A grommet.



Compress the reserve pilot chute, without getting any fabric caught inside the coils.



Secure reserve pilot chute with temp pin.



Spread out the fabric completely, and ensure that no fabric is caught inside or underneath the reserve pilot chute coils.



Accordion fold back the reserve pilot chute fabric side closest to the #3 flap, until approx. 1" wide.



Close #3 flap, while keeping fabric in place, and secure with temp pin.



Accordion fold back remainder of reserve pilot chute fabric, top then sides, until all fabric is folded back approx. 1" around the cap of the reserve pilot chute.



Close #4 flap, while keeping fabric in place, and secure with temp pin.





Close #5 flap, while keeping fabric in place, and secure with temp pin.



Close #6 flap, while keeping fabric in place. Place reserve pin through marine eye or Spectra rip cord eye first, then insert into reserve closing loop.

Seal container and complete all necessary paperwork.

## OPTIONAL STAGING LOOP INSTALLATION



Tie double overhand knot onto staging loop



Insert into 2nd grommet at bottom of the container. Ensure that staging loop is 1" shorter than reserve closing loop.



Pull the reserve closing loop through the reserve bag and secure with a temp pin. Pull staging loop through reserve bag. Ensure that no canopy material has pulled through the grommet.



Place the AAD into the indentation, and place the lower corners of the reserve pack job into the reserve container. Fill bottom corners of reserve container completely with bagged canopy gradually, moving from side to side.



Thread the pull-up cord through the AAD cutter before passing through flap #1 bottom kicker flap.



Secure flap #1 with temp pin.



Pull staging loop through staging loop grommet on flap #1 and secure with temp pin.



Extend reserve bridle straight from free bag to hinge point of #3 flap, and fold back.



Fold bridle in half width wise, and into a quarter



Insert the bridle approx. 1" into the staging loop.



Fold the bridle diagonally along both sides of the center grommet, until 6" before the Skyhook, and place these folds under flap #1.

## CHAPTER 4 – MAIN PACKING & CLOSING

### SELECTING THE CORRECT STOW BANDS

- Rubber bands meeting MIL-R-1832 are recommended. The following sizes are used based on canopy selection.
- 2"x 3/4" rubber bands are used with Dacron lined main canopies.
- 2" x 3/8" rubber bands are used with Vectran lined main canopies

\*Substandard rubber bands should be replaced immediately.

### INSPECTING MAIN CANOPY & COMPONENTS

It is highly recommended to inspect the main canopy after 25 jumps in areas including but not limited to:

- Drogue envelope
- Drogue bridle and centerline (Check calibration and general wear)
- Check Drogue Disk, attachment pin and screws
- Main Deployment bag and grommets
- Bridle attachment point on top of and inside of canopy
- Canopy fabric, tapes, seams, suspension lines and attachment points
- Control lines, brake lock loops and toggle attachment
- Slider & grommet condition
- Connector links & slider bumpers
- Inspect the Sigma disk release system
- Main closing loop
- Main container D-rings
- Recoil ripcord system

### ASSEMBLING THE MAIN CANOPY TO THE MAIN RISERS



Place and pair main riser with correct line group and link



Fold end of riser inside towards the middle



Open hard link completely, ensure no sharp edges.

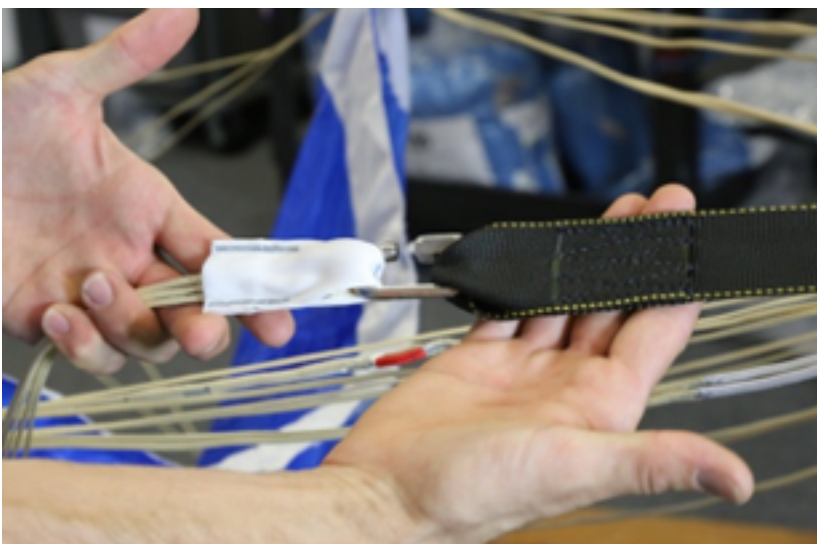

Attach the hard link, with barrel closest to the riser, ensuring correct continuity of lines

Hand tighten hard link

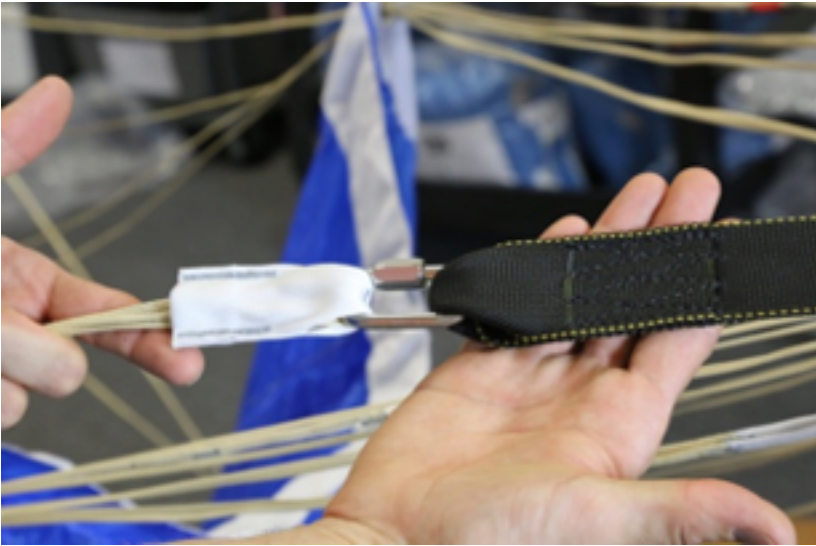

Use a wrench to tighten hard link, approx. 1/8 turn or until appropriately tight. Do not over tighten which may cause damage to link!

Repeat for remaining hard links



## ATTACHING THE PRIMARY & SECONDARY TOGGLES

Insert primary control lines through large guide ring, then through primary toggle grommet (gold toggle).





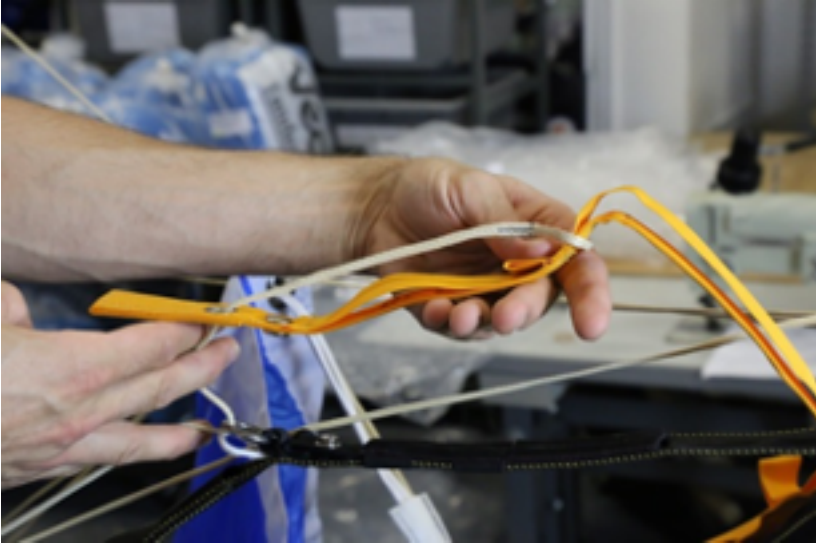

Loop control line end over bottom of toggle. Tighten lark's head and place toggle onto riser



Insert secondary control lines through small guide ring, then through secondary toggle ring (black toggle).



Loop control line end over bottom of toggle



Tighten lark's head and place toggle onto riser

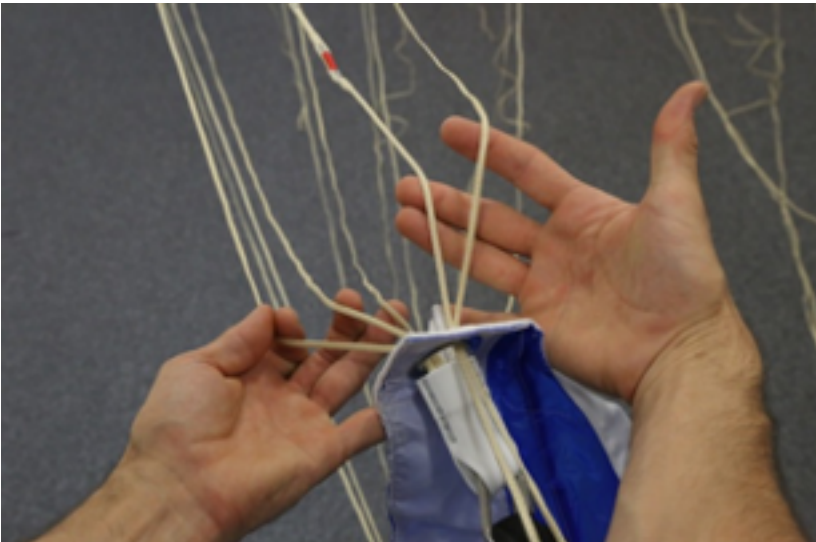

Always ensure correct line continuity after attachment

## ATTACHING MAIN BAG AND DROGUE

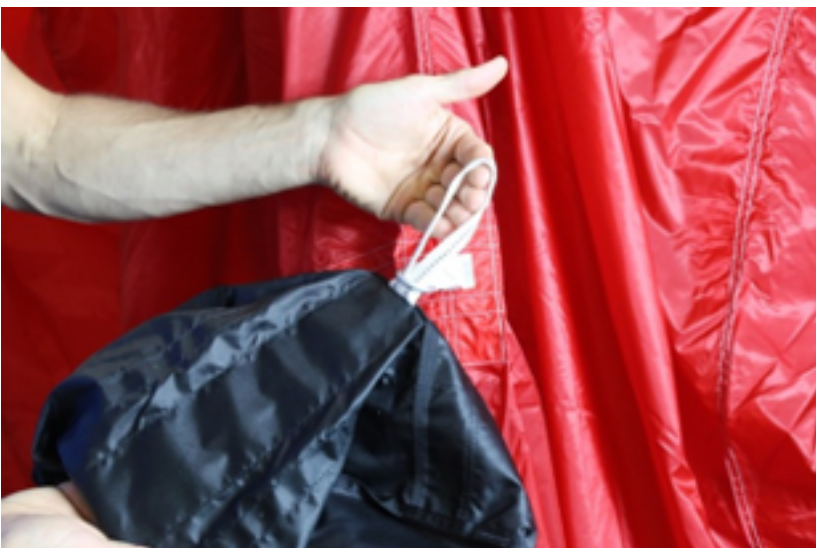

Route inside loop of main bag through eye on bridle attachment point.



Route bag through loop.



Tighten up lark's head knot

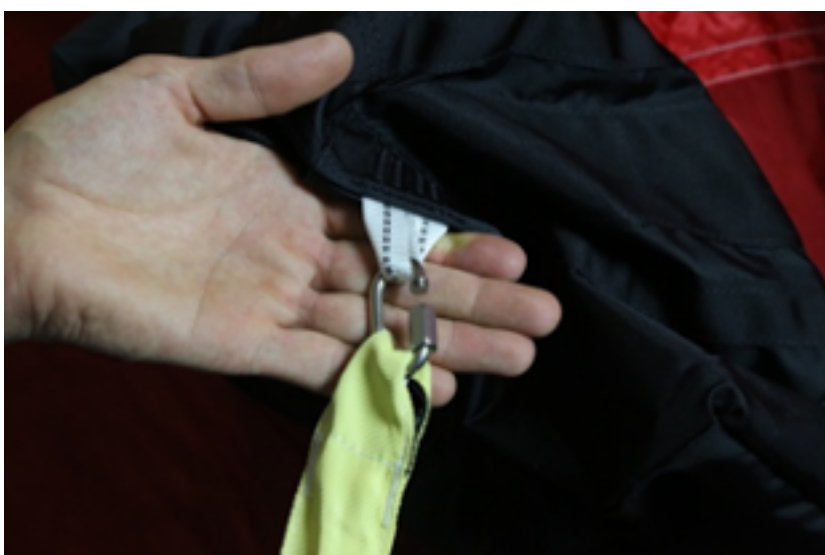

Attach drogue end to outer loop, using hard link.



Ensure that the center line is attached to hard link and hand tighten.

**(If the center line is not attached or breaks, the drogue will not collapse on deployment. This will result in harder openings of the main canopy.)**



Use a wrench to tighten hard link, approximately 1/8 turn or until appropriately tight. Do not over tighten which may cause damage to link!

## ATTACHING MAIN BAG AND DROGUE



**The Sigma & Micro Sigma Main Deployment Bags have undergone a design improvement to help reduce wear on the 1" WHITE tubular nylon drogue attachment point.** Both main deployment bags (Sigma and Micro Sigma) now come with an additional RED Type IV loop bridle attachment point in addition to the 1" WHITE tubular nylon loop.



**The correct method for attachment of the drogue for this new design assembly is to:**

- Pass open #5 steel link through RED Type IV tape loop.
- Pass open #5 steel link through WHITE 1" tubular nylon loop.
- Pass open #5 steel link through bridle (either Kevlar or Type 12), ensuring that the #5 steel link also passes through drogue center line.



Use a wrench to tighten link approximately 1/8" past hand tight. Do not over tighten steel link as damage may occur to link.

## SETTING MAIN CANOPY BRAKES



Route Dacron loop through primary control line cat eye.



Route Dacron loop through guide ring.



Insert top end of primary toggle (gold toggle) through Dacron loop, then insert top end of primary toggle end into keeper.

Place bottom end of primary toggle into pocket and snap into place.

Insert secondary toggle (black toggle) into pocket.



Place excess brake line into keeper on backside of riser.

Repeat for opposite side

## PACKING THE MAIN CANOPY



Follow lines up to the slider. The line groups must be clear up to the canopy, and pass through the slider grommets.



Place canopy over shoulder, and flake the nose counting each cell. When you have the entire nose flaked, tuck it between your knees and hold it there.



Clear the stabilizers. Flake each side outwards, with lines and line attachment points placed in center. Quarter the slider. Clear the tail, flake the material between each steering line outwards, with lines and line attachment points placed in center.

Reach to grab the tail, to prepare for wrapping and cocooning the entire canopy. Take care not to pull any lines away from the center.



Push the nose of the canopy back so it becomes straight down without any overexposure.

Folding the nose slightly inwards is optional. Do not push the nose into the pack.



Cocoon the canopy with the tail. Do not pull excessively on the tail and take care not to pull any lines away from the center.

Hold the lines in one hand with tension forward, and use your free arm to support the canopy fabric while gently placing the canopy on the packing surface





Dress the canopy with tension forward, after placing it on the ground it is to appear taller than wider.



Squeeze the air out of the canopy, paying attention to not moving any lines away from the center. Always push forward to maintain tension on lines



Folding the canopy towards the center will help control lines.



Dress the canopy with tension forward, after placing it on the ground it is to appear taller than wider.



Squeeze the air out of the canopy, paying attention to not moving any lines away from the center. Always push forward to maintain tension on lines



Folding the canopy towards the center will help control lines.



Repeat for opposite side, to remove all air.



Cocoon the canopy using the center cell. Ensure the canopy is wrapped entirely.



Front view



Remove remainder of air.



Prepare main deployment bag.



Make first S-fold according to depth of bag.



The first fold will also hold the slider in place, so ensure firm folds of the canopy and slider fabric.



Hold down first S-fold with knee.



Reach underneath canopy in preparation for second S-fold.



Make the second S-fold.



Complete the second S-fold.



After 2nd S-fold tuck ears underneath and above 1st S-fold to depth of bag.



Secure S-fold with D-bag. Insert half of the canopy into the D-bag.



Repeat previous 2 steps for other side.



Finish placing the main canopy into the bag



Secure D-bag with first 2 stows, ensuring proper tension. Line bights must be approx. 3", using the next grommet out as a reference helps.



Stow the remainder of lines. Leave about 2 feet between the last stow and the risers.





Stow your main risers alongside of the reserve container. Make sure the risers are not underneath tuck tab flap over shoulder.



Stow the main risers under the yoke flap and close the magnetic riser covers.



Neatly S-fold remainder of lines in the main pack tray and not over top main flap #2.



Place D-bag in container with line stows to bottom of container.



Arrow on disc should be pointing up towards reserve container.

**(If the screw in the drogue disc is loose, it can snag the main closing loop. If the screw is missing, the drogue will not inflate upon drogue set.)**



Thread main closing loop through chimney of disk, and secure with main pin, as shown in picture. Doing so will allow you to immobilize the disc for cocking.



Set the drogue before closing the container, and make sure the limiter tapes are completely taut.

***(If the drogue has not been set during the packing process the tandem pair's terminal velocity will increase. The drogue should inflate within 6-8 seconds in this configuration if there is no other drogue entanglements upon deployment.)***

***(Drogue centerline should be inspected and calibrated if needed, every 25 jumps.)***



Notice that the Kevlar bridle on the left side of the container is scrunched up after you set your drogue. Position and keep the scrunched Kevlar bridle on the left side and on top between the D-bag and reserve container.



Using a length of 725lb or 1000lb spectra pull-up cord. Thread through D-rings and around the disk to close container.

Diagram of closing sequence is provided on main pin cover flap.



Pass the pull-up cord through grommet on bottom flap.



As the four (4) flaps are drawn together, check that the disc has remained centered with arrow pointing toward the reserve container, with D-rings evenly spaced.

Secure with main pin, making sure the D-rings, bottom stiffener, and main closing loop are all below the top flange on the disc.



Place the main pin at 11 o'clock position and ensure that both recoil ripcords are clear and not twisted, as illustrated on the main pin cover.

**(Twists in the recoil ripcord can cause hard pulls.)**

Once secure, carefully remove the pull-up cord.



Insert safety pin (attached to drogue bridle) through main pin eyelet into grommet.

**(Main pin should be inserted from the bottom of the container upwards. If it is inserted incorrectly it can cause a hard pull – drogue in tow.)**

The curved part of the safety pin must be fully inserted to function correctly.



Place drogue bridle underneath right main side flap without excessive tension on safety pin.

Secure the 2 small tuck tabs on pin flap underneath bottom main stiffener.



Close the magnetic main disk cover securing it on the main top flap just under the bottom of the center flap.

## PACKING & STOWING THE DROGUE



Layout drogue in a nice flat, circular fashion.



Fold drogue in half down towards the bridle.



Fold drogue over in 3rds. Fold drogue in half towards the handle.



S-fold remainder of bridle on top of each other leaving approximately 15" of loose bridle.



Fold canopy over/across bridle in 3rd's.



Fold across once more making the folded drogue approximately 15" x 6".



Insert drogue in its pouch and tuck bridle away so it is not visible.

**(Ensure that the opening fold of the drogue is facing the back of the container when inserting it into the pocket.)**



This completes the packing sequence for Sigma.



**SECTION 3: INSTRUCTOR TECHNIQUES**

CHAPTER 1: PREPARATION

CHAPTER 2: IN- AIRCRAFT EXITS

CHAPTER 3: FREEFALL / DROGUE FALL

CHAPTER 4: CANOPY CONTROL

## CHAPTER 1: PREPARATION

### REQUIREMENTS FOR JUMPING

The following is the minimum criteria to be followed and will be discussed under the headings of:

- Personal requirements
- Geographical requirements

#### Personal requirements

Before any Tandem jump, it is important to determine that the student meets a few basic criteria. There are very few restrictions on who may jump, but the few guidelines put forth here must be followed carefully in order to protect yourself, the student and the entire Tandem program. The four student requirements are:

- **Age:** The minimum age is 18. Warning: It is the responsibility of the drop zone and the Tandem Instructor to ensure the student is of legal age.
- **Physical condition:** There is very little that precludes someone from making a Tandem jump. The student should be in good health, with no heart conditions or any other debilitating ailment.
- **Weight & Size:** There are many factors to be considered when considering student weight & size.
  - The total combined exit weight of the Tandem Instructor, student and equipment must not exceed 500lbs. (550lbs with approved SR-340 or SR-370 reserve)
  - Tandem Instructor must have enough experience and skill to control the student with whom they are jumping with, regardless of their difference in size.
  - The Tandem Instructor should be able to steer and flare either the main or reserve canopy without the help of the student.
  - If a large Tandem Instructor is taking a large student, it may be impossible for them to safely exit from a Cessna or similar aircraft. However, the same pair could easily exit from a Sky van, Twin Otter or similar aircraft. Aircraft availability must be taken into consideration when deciding if a student may jump.
- Tandem Waiver Video must be shown to every student prior to making a tandem skydive.
- The Uninsured United Parachute Technologies, LLC Tandem Parachute Jumper Agreement waiver must be completed by the student prior to making a tandem skydive.

#### Geographical requirements

The following may play a part in how you decide who to take on a given day or at a specific location.

- **Weather assessment:** For Tandem jumping, the optimum range for winds is 5 - 20 mph. All jumpers should realize that very high winds are unsafe to jump in. In the case of Tandem jumping, we need to realize that it may be equally unwise to jump in extremely low winds. Heavy students with any physical malady which can prevent them from running or supporting their own weight should not jump in no-wind conditions.
- **Temperatures:** As the seasons change, the canopy's performance will vary as the air becomes cooler or warmer. Cooler air is always more stable and dense so the canopy's decent rate and flare performance is good. Warmer air is thinner and you may find that landings become harder. This can be noticeable even during the course of a day as the temperature rises on a

hot summer day. The warmer air actually provides an effect in which the field elevation can be thought of as being barometrically higher than its geographical elevation. This effect is referred to as "density altitude". The hotter the day, the thinner the air and the higher the density altitude. In other words, on a hot humid day the canopy may land as if the field is at perhaps 6,000ft (1800m) rather than sea level - a BIG difference! On a very hot day with a heavy student, density altitude is a factor you must take into account. Common sense, good judgment and caution are often called for.

- **Terrain assessment:** Selecting the landing area is important. If planning a Tandem jump at an unfamiliar spot, check the landing area before jumping. Take note of where the obstacles are and keep track of other large open alternate landing areas. Turbulence can affect canopy flight as much as ¼ mile away from tall obstacles. Keep these things in mind when making a note of wind direction and spotting. Think ahead and plan carefully.
- **Altitude:** When jumping at locations above sea level, the higher ground elevation will make the flare less effective. Familiarize yourself with the different canopy characteristics by selecting lighter students to jump with.

## OVERVIEW OF THE JUMP

- **Synopsis of the jump:** Before the first jump it is important that the student understand what the jump will be like and what is expected of him or her. Before the first jump the student should have the Tandem concept explained by video, still photos or direct observation. Inform them of the entire sequence and what to expect at each stage of the jump. Information such as exit altitude, length of freefall delay and length of canopy ride are all motivating points of interest.
- **Video and assumption of risk agreement:** The student MUST view the waiver video and sign the waiver. Be careful to abide by all Uninsured United Parachute Technologies, LLC & USPA provisions. If the video machine is out-of-order or the recording is lost, it should be considered the same as if the aircraft is inoperative. NO ONE may make a Tandem jump without seeing the waiver video and signing the waiver.

## BRIEFING THE STUDENT FOR THE FIRST JUMP

One great advantage of Tandem first jumps is that the student does not need to know nearly as much as when making their first solo jump. The student can therefore relax and enjoy the jump rather than worry about forgetting the hundreds of facts necessary to make a jump on their own. With the student more relaxed their mind will be free to absorb the experience and pick up specific skills impossible to teach effectively in a classroom. If a picture is worth a thousand words, a Tandem jump is worth hours of classroom instruction. In other words it is possible to over train a student before a first Tandem jump. Emphasis should be on safety and awareness. This section is broken into two sub-sections:

- Skills practice
- Checklist practice

On subsequent Tandem jumps more time can be spent in preparation for the jump and the student can be given more technical training under canopy. Remember, under this program, Tandem jumping is to be used as a student training aid, NOT for the purpose of giving "joy rides" to the general public.

***(Remember: A student with too much to remember and do will experience sensory overload more often than a student focused on one or two simple tasks.)***

**Skills practice**

Preparing the student will make a great difference in how successful the jump is. A well conducted practice will help the student understand the program, eliminate confusion, increase the student's confidence in the equipment and you (the tandem master) all of which will keep the experience an enjoyable one. The following tips will ensure that the practice is effective:

- Clearly explain what will happen.
- Practice with realism.
- Repetition of skills results in instinctive performance of skills.
- Obtain feedback from your student. This will let you know if further explanation is needed, and whether they are actually learning.
- Practice until perfect, and remember:
- What is performed on the ground will almost certainly be performed in the air. but there is no guarantee, so a tandem instructor must always be ready for the unexpected).

**Checklist practice**

When performing a Tandem jump, the student must know the following information and drills prior to disembarking on their first jump. Complete details of these topics and more can be found in Section 5 under Student Briefing. The following will include a summarized list of key points:

- **Aircraft procedures**
  - Moving to the aircraft
  - Seating arrangement in the aircraft
  - Aircraft emergencies
- **Freefall body position drill**
  - Have student lie horizontally to practice realistically.
  - Have the student grasp the harness in the elbows back position.
  - The student's feet should be together with knees bent at 90 degrees.
  - Practice arm extension, prone, if you intend your student to do it.
  - Practice the signal, tap on the shoulder, with the arm extension drill.
  - NEVER REACH AROUND IN FRONT OF THE STUDENT FOR ANY REASON.
- **Exit practice and hookup procedures**
  - Perform drill at the aircraft or aircraft mock-up.
  - Practice the proper hand and foot placement and set up for the exit launch.
  - Have student practice solo as well as hooked up for realism.
  - Practice the whole sequence from exit.
- **Sit back drill (For student comfort)**
  - This drill must be practiced on the ground
  - Practice with the student's harness attached to your own to simulate tension.
  - Have student sit in the harness.
- **Steering and flaring the canopy**
  - Display steering toggles to your student so they understand what they are and how to grasp them. This would best be done prior to the jump.
  - Explain how the canopy is steered. Explain how turns are initiated and stopped (no countering necessary), what position is full flight as well as what flaring is and how it is performed. This may be done during the canopy flight.
  - Never let the student reach back behind them

- Never let the student grab on to anything except their harness or the toggles if briefed to do so.
- **Landing practice**
  - If the student is to assist with the landing flare, in-air practice is a must. We recommend at least three good repetitions.
  - Extra landing training may be required, if the student is heavy (over 200lbs), the tandem pair is landing at high altitude, or in light wind, or in general for a new tandem master.

## STUDENT HARNESS ADJUSTMENT

Please refer to SECTION 2, CHAPTER 2 Student Harness Fitting and Adjustment for details.

## PRE-FLIGHT GEAR CHECK

*The responsibility of pre-flying a UPT tandem system belongs to the instructor making the jump on that system.*

**Student equipment:** Start by checking to see that your student has a proper, tight fitting jumpsuit and any other items they may need such as a leather helmet, goggles, altimeter and/or gloves. Goggles should be snug fitting. The use of any open toe and/or open heel sandal and/or "flip flop" footwear is forbidden. Students wearing contact lenses should use goggles with as few air vents as possible. Again, check the fitting of the student's harness to make sure nothing has loosened and that all webbing running ends are stowed properly. Check in the following order.

- Upper snap position
- Chest strap position and tension
- Hip strap & back strap position and tension
- Leg strap tension and running ends are secured through at least one stationary keeper
- Proper staging of side quick ejectors
- Y - strap

**Tandem Instructor equipment:** Prior to checking the system, select your jumpsuit, helmet, altimeter, goggles and any other accessory items you may need. As with Students, the use of any open toe and/or open heel sandal and/or "flip flop" footwear is forbidden. When selecting a jumpsuit pick one that is looser in the arms and legs to help give you extra drag. This will enhance stability with light students and help to eliminate rocking in drogue fall. It is recommended that you use a wrist mount altimeter as chest-mount altimeters positioned between you and the student will probably not give an accurate reading.

Before putting on the Sigma Tandem, perform a thorough and systematic gear check. Always start your gear check at the same point and systematically move from item to item until completed. An example of this would be: start with the reserve pack data card, then the drogue pouch working up the back of the rig then down the front. When performing the check you should cover the following points:

- Drogue handles: Check to see that the drogue deployment and drogue release handles are easily accessible. Each time the handle is checked, grasp as if you intend to pull it.
- Main Pin Closing and bridle routing: Ensure that the main pin is orientated correctly according to the diagram on the main closing flap. Make sure that the bridle is correctly routed and secured under the right side main container flap.
- Disc and safety pin on bridle: Ensure that the safety pin is securely seated in the main closing pin.
- Reserve pin, closing loop & RSL routing: Open the reserve pin cover and make sure the pin is properly seated and that the condition of the closing loop is good. Don't push the reserve pin too far down into the loop (this will cause it to twist, making the eyelet of the pin stick up instead of lying flat). Check the RSL routing.
- 3-Ring assembly: Make sure the rings are hooked up in the proper sequence and that the loops are not frayed. The loop should pass through only the small ring, then through the riser grommet and finally through the housing grommet. The loop is then secured with the yellow cable.
- RSL Shackle attachment & Collins lanyard: Make sure that the RSL shackle is secured and connected. Ensure that the long side cutaway cable passes through the yellow loop of the RSL lanyard.
- Cutaway and reserve handles: Check that the handles are securely placed. The Velcro attaching the handle should be fully mated with the handle being placed up as close to the housings as possible to prevent excess exposed cable.
- Main Lift Web (MLW): Adjust the MLW to the length that provides proper fit and check both sides for symmetry.
- Main riser covers and container flaps: Check for proper closure of the following:
  - Reserve Pin Cover
  - Main Disc Cover
  - Riser covers
  - Note: Check that main risers have not been left exposed by an untidy pack job. They should be tucked down the side of the reserve and under the bottom of the riser covers toward the main container. Unprotected risers can also be a danger when moving around the cabin of small aircraft.
- Automatic Activation Device: The AAD must be on when boarding the aircraft and during jump. The AAD must be either dedicated TANDEM, or in TANDEM mode if using a multi-mode AAD. (Please refer to the documentation supplied by your manufacturer.)

## CHAPTER 2: IN-AIRCRAFT & EXITS

### IN-AIRCRAFT GEAR CHECK

This section is split into areas of safety checks:

- Pre-exit preparation
- Pre-exit gear check
- Drogue handle check

#### Pre-exit preparation

While in the aircraft (before jump altitude is reached), verbally acknowledge the hookup of each top snap as it is clicked into place. Make sure the side attachment quick ejector snaps are secure and are comfortably tight. Make sure that student's chest strap is not overly tight. Make sure all loose straps and webbing is securely stowed.

#### Pre-exit gear check

Plan ahead of time and brief someone on your load to do the final pin checks for main and reserve. Before exit, the Tandem Instructor should physically check the following items:

- All harness connection points
- All handles in order of use
- Reserve static line
- Excess webbing on Student's leg straps, waist band, chest strap, helmet, and goggles

#### Handles check

All handles can be dislodged by movement in the aircraft or during exit as you pass through the door. It is required that the Tandem Instructor check the security of all handles just before exit and then again just after drogue deployment on every jump.

Always follow this process:

- Check security of all handles.
- Move to exit position.
- Re-check security of the drogue and drogue release handles prior to committing to the door.

### EXITS

Exit procedures vary with different aircraft but the basics remain the same. You must maintain total control of the student during exit and freefall.

#### Poised Exit

With a poised exit, the student assumes the correct freefall body position. This allows the instructor more control over the exit while the student remains passive.

#### Diving exit

This exit can be done from kneeling, sitting or standing positions. This technique, for many aircraft, is most preferred as it limits the amount of time the Tandem pair spends at the open doorway or hanging outside the aircraft.

**Exit tips**

- Spend as little time as possible while hanging onto the outside of the aircraft, or while near the door. The longer you spend there the more you increase the chance of something going wrong.
- The student must have a good grip on their own main lift webs. A student with free hands can only get you into trouble. A common procedure is to have the student place their thumbs under the MLW on each side of the harness and lightly grip the MLW. Students should not cross their arms across the harness, this promotes de-arching on exit.
- The student's head should be back, body arched, feet together and weight supported by you before exit.
- The actual exit should be so smooth that the student hardly notices the difference between hanging under you, outside the aircraft or in freefall.
- The fall away from the aircraft should be head high and very stable. The more unstable your exit and fall away, the more likely the student is to move which will cause trouble.
- If exiting from a small side door, a kneeling or sitting exit is recommended.

**Exiting different aircraft**

Do not assume that all aircraft are the same. When jumping from an unfamiliar aircraft, it is required to practice the exit position and procedures. This is necessary to ensure a controlled exit.

The use of a hand camera (HandCam) should not influence or effect proper exit technique.

The 3 leading causes of unstable exits are:

- Bad set up, launch and Flyaway (not achieving stability before throwing the drogue)
- Tight jumpsuit without drag on tandem instructor or newer tandem masters jumping in shorts and t-shirt before building proper exit technique repetition.
- Poor exit technique. (Often Hand Cam induced.)

Backing out of a side door aircraft is forbidden on exit



## CHAPTER 3: FREEFALL / DROGUE FALL

### ALTITUDE RECOMMENDATIONS AND REQUIREMENTS

**Exiting the aircraft:** It is important to exit with sufficient altitude to respond to a variety of situations. The speed and altitude lost during unstable freefall without the drogue is hard to imagine for the uninitiated Tandem Instructor candidate. Unusual situations such as an uninflated drogue or drogue in tow will eat up your altitude faster than you can imagine. Refer to Section 4: Emergencies and Malfunctions, for details on the possible problems you may encounter.

Minimum exit altitude is 7500ft (2286m) AGL. (Feet leaving the plane. Take into consideration parasitic drag on smaller aircraft such as a Cessna 182)

**Deploy drogue after exit:** One must make every effort to deploy the drogue in a stable position within 5 seconds after exit. It is critical that the drogue is not used to gain stability and the instructor must make every effort to stay in control after exit.

After 10 seconds, the reserve must be deployed to avoid reaching tandem terminal speed which can exceed 170mph. Maintaining altitude awareness at tandem terminal speed is challenging as illustrated below.

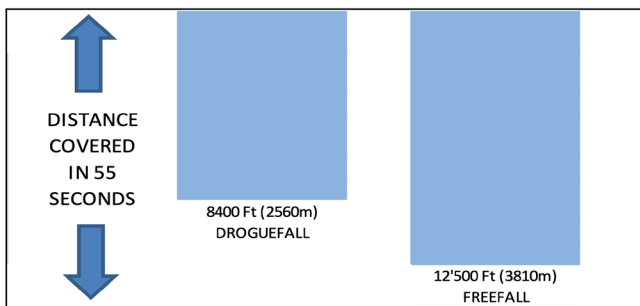

**Main deployment:** Due to the complexity of the tandem system, a higher opening altitude is required compared to solo sport jumping. Minimum fully open main canopy altitude is 4000ft (1219m) AGL.

**Reserve deployment:** Due to the complexity of the tandem system, a higher opening altitude is required compared to solo sport jumping. Minimum fully open reserve canopy altitude is 3000ft (890m) AGL.

### STABILITY CONTROL

**Arch:** What the Tandem Instructor does is more important than what the student does. The Tandem Instructor should concentrate on good training for the student in the proper body position on the ground, and then on his or her own body position on the exit with focus on using the relative wind to achieve stability. If the Tandem Instructor attains a good arch in the relative wind right out the door, then chances are the pair will gain stability easily. Incredibly enough, many instability problems are caused by a bad Tandem Instructor body position. Specifically, many problems start because the Tandem Instructor fails to throw a hard arch on exit and ignore the relative wind. While a poor exit resulting in instability is not inherently dangerous (except when it leads to unstable drogue deployment), it is nonetheless unnecessary and unacceptable. A poor exit is defined as any exit creating a combination of uncontrolled loops or rolls immediately after exit. It is not acceptable to loop an AFF exit, nor is it acceptable to loop an airplane on takeoff with a first-time student, and Tandem is no different.

**Anticipation:** The key to keeping control is being able to recognize a potential problem prior to it becoming a real problem. Students sometimes do crazy things during the first few seconds after exit. Usually, after the initial shock of freefall their eyes will reopen and they will attain their body position assisting stability. Immediately following the exit launch, assess the student's body position as you arch to maintain stability. If the student remains in the folded de-arch position of the diving exit or attains a de-arched position after the exit launch, you may have to apply additional control techniques to maintain heading and stability.

**Manipulation:** One such control technique is to physically manipulate the student's body into an arch. To do this reach around with your arms and/or legs and pull the student back into the correct position. Grab the arms only between the elbow and the wrist. This makes it hard for the student to grab you. Hold this interlocked or body locked position until you have ensured or regained stability. Manipulation should only be used as a last resort if the Tandem Instructor's hard arch combined with body rotation into the relative wind is ineffective. Remember, if you as the instructor is not using your arms and legs to fly your body, it can become easier to lose control. This technique must be used with caution as it increases the possibility that the student will grab your arms and prevent you from pulling. There is simply no telling what a student might do if presented with an

## DEPLOY DROGUE

- Ensure stability prior to deployment: Proper student training will assist in achieving stable body positions prior to drogue deployment as will a powerful exit from the tandem instructor.
- DO NOT USE THE DROGUE TO GAIN STABILITY: Be stable or gain stability before the drogue is deployed. You should not try and just time your drogue deployment.
- Drogue deployment:
  - Locate drogue handle and grasp firmly.
  - Pull drogue from pouch and throw aggressively to your side at full arm extension.
  - Release immediately once forward of the line of your shoulders.
  - Watch drogue inflate over your right shoulder (you may or may not feel the drogue inflate)
- Once drogue has inflated immediately perform all handle checks :
  - **Primary** (left side) drogue release, counter with right arm above head
  - **Secondary** (right side) drogue release, counter with left arm above head
  - **Cutaway handle**, counter with left arm above head
  - **Reserve handle**, counter with right arm above head
  - **RSL**, counter with left arm above head
  - Altimeter Check

## DROGUE FALL TECHNIQUES

The drag of the drogue on the container system will place the tandem pair in a certain attitude while in drogue fall. The drogue will resist your efforts to change this attitude. If you try to change your pitch attitude (head high/head low) too much, you will rock up and down. There are four things you can do to minimize rocking:

- Tandem Instructor corrects body position. The best way to stop rocking is for the Tandem Instructor to simply relax and lie still in freefall not moving the legs back and forth.
- Teach the student correct body position on the ground (head back, hands on harness, back arched from shoulders to knees, and feet tucked up).
- Wear a big, baggy jumpsuit and put a tight suit on the student as the air hits them first. A big jumpsuit will assist in maintaining control over poor body position during exit or drogue fall. As the instructor gains experience, jumpsuit size becomes less critical.
- Snug down the hip straps so they are comfortably tight. Straps that are too loose can cause the rocking action as well.

## ARM EXTENSION (OPTIONAL)

Once the drogue is deployed, tap the student's head or shoulder to indicate it is time for them to put their arms out in normal freefall position. DO NOT reach around and pull the student's arms into position, as this would give the student a chance to grab your arms. Another recommended technique is to grab the student's elbows or push them up and away from their body; this will usually cause them to release their grip on the main lift web.

***(Immediately after drogue release as the "trap door effect" develops, the tandem instructor should immediately return to a neutral box-man position or hands in a more forward position above the head causing a more head up position and fly the tandem pair through the deployment and trap door effect.)***

## DROGUE RELEASE

The drogue may be released at any time during "drogue fall." To release the drogue (thus deploying the main canopy), pull either the drogue release handle located at the bottom left-hand corner of the main container, or on the right front leg strap. A pull of approximately 5" will release the drogue.

When you release the drogue you may feel a trap door effect, which is the momentary acceleration prior to the main canopy inflating. If you pull the release handle completely and do not feel this sensation, your drogue may have failed to release. See Section 4 for emergency procedures.

***(Immediately after drogue release as the "trap door effect" develops, the tandem instructor should immediately return to a neutral box-man position and fly the tandem pair through the deployment and trap door effect.)***

The now partially collapsed drogue acts as a pilot chute and pulls your canopy to line stretch in about half a second. The canopy will then open slowly.

(The drogue centerline should be inspected and recalibrated as needed, every 25 jumps.)

**If the student is trained to deploy the main drogue release additional training must be provided:**

- **Be given an altimeter and trained how to use it. 3 PRCPs, with full gear on.**
- **Relative Work (RW) is not permitted if the student is trained to deploy the main canopy. This includes a videographer and tandem pair taking grips with one another.**

**(Avoid showing your student your altimeter during droguefall and during the waive off and/or deployment sequence. Students may grab the instructor's arm as a result.)**

## CHAPTER 4: CANOPY / LANDING

The opening sequence begins as a slight streamer with the slider high. The fall rate of the Tandem pair decreases steadily for several seconds in this configuration. Then the slider descends and the canopy opens with the end cells open and the slider almost down to the links.

### UPON OPENING

- Perform canopy check and release toggles: Check canopy condition while locating the toggles. Release brakes using the yellow outboard primary toggles. Perform a controllability check: Flare the canopy and turn the canopy in both directions. Pick up black inboard flare toggles and repeat the same sequence. Once you are satisfied that the canopy can be controlled in both toggle configurations, you may release the black inboard toggles until it is time to pick them back up again for landing. The black inboard toggles must be picked backed up again no lower than 1000ft AGL. The tandem Instructor is checking sky for other canopies while performing these tasks.
  - Check main links & risers.
  - Check the 3-ring release system & RSL.
  - Check the top student attachment snaps.
  - Check the location & security of the cutaway and reserve handles.
  - Check the student harness for comfort, adjusting if needed.
  - Release the lower attachment quick ejectors, loosen the lateral webbing. Having the student stand up on the instructor's feet will assist in this procedure. Do not tell the student the lower attachments are being released; simply inform them that harness adjustments are being performed. It is important to re-attach the quick ejectors back to the instructor immediately.
  - If ground winds are high, release the reserve static line shackle in case you have to cutaway the main canopy to avoid a drag situation after landing.
- Instruct the student to sit back in the harness: Have the student perform the "sit back in harness drill" as described in Student Briefing. Student should lift each leg to ease the leg strap and pad forward 1-2 inches to alleviate the pressure on the inside of the thigh

The instructor has the option of handing the yellow outboard steering toggles to the student. Hand the student the steering toggles while instructing them to grab the lower loop. After the student has placed their hands in the toggle lower loop, you may choose to remove your hands.

### STEERING THE CANOPY

A Tandem system is the ultimate suspended harness. The student can gain experience controlling a ram-air canopy. How much can be accomplished depends on the student's aptitude and previous training or experience. Not everything can be covered on the first jump. Learning points that would be covered on the first jump are listed in Student skills for first jump, Chapter 1, Section 5 of this manual.

Once the student has a firm grip on the toggles, provide commands as to the direction that they should steer. Encourage them to pull down part way initiating a slow, flat turn and to pull down all the way performing a full bank turn.

Demonstrate forward flight with hands all the way up (this can be a difficult position for the student). When setting up for final approach, explain the procedures with reference to the target. If the student is assisting for landing, have them perform 3-5 practice flares while at altitude with

feedback of their technique and overall performance.

If student reports nausea at any time, keep turns to a minimum and tell student to look at the horizon and breathe normally. Have student reposition the leg pads or perform sit back in harness drill again. The instructor can slightly loosen the chest strap. If student's fingers start to tingle, instruct them to let toggles go and drop both hands to their side. An overly tight MLW will restrict upward arm and shoulder movement. Full flight arm position can be very tiring and difficult for the student.

## LANDING

- **Prepare for landing:**

- **Landing position:** During canopy flight, it is important to physically practice body & leg position as required for landing. Emphasize that the feet and knees should be together and forward, with knees slightly bent unless instructed otherwise. It helps to have the student reach and grab under their knees with their hands to help lift the legs even higher for the landing.
- **Enter landing approach pattern:** At 1000ft (300m), enter the downwind leg of pattern. Assess the surface winds while flying past the target area to make final alterations to the final approach. Try not to sit in the braked position for an extended length of time as it will tire the arms out prior to the flare. Upon entering the landing pattern, if the winds are high and there is no catcher present, it is permissible to release the reserve static line (RSL). This is accomplished by lightly pulling on yellow tab of the snap shackle. With the RSL detached, the main canopy can be released after landing if being dragged. This will prevent the RSL from deploying the reserve parachute.
- **Student assisted landing:** The instructor should always have the capability to land the canopy without student assistance. DO NOT allow an untrained student to assist in the flare.
- If student has received ground training, is well rehearsed in the air and has proven capable they can assist the flare on the instructor's command. The student should not be allowed to overpower the instructor during the flare.

- **Landings:**

There are three (3) kinds of Tandem landings: (NOTE, all three landing require the tandem instructor's feet to touch the ground first!)

- **Stand up:** When the wind is over 10 mph, a proper flare should yield a "no forward speed" stand up landing. All the student has to do is keep enough leg tension to support their own weight. When the wind is high, have the canopy catcher(s) waiting at the landing area. Hand the toggles to the catcher(s) at touchdown. The catchers must be trained to meet the tandem pair as they land into the wind and fully collapse the canopy. If the student is assisting with the flare, they MUST release the toggle immediately after touchdown so that the catcher(s) can perform their job. This procedure should be rehearsed with the student during flare practice under canopy.
- **Walking landing:** When the wind between 5 & 10 mph, both Tandem Instructor and student must take a few steps after touchdown. If the student does not have proper leg tension or does not take those few steps, they will fall down and pull the instructor down with them. This kind of landing is the most difficult and takes considerable student preparation. Prior to touchdown in light wind, the student must raise legs up and forward keeping knees bent.

The Tandem Instructor must be able to see the feet and knees when looking over the students shoulder. The Tandem Instructor can also use their own feet to coax the student's feet into the proper position.

- **Sliding landing:** When the wind is less than 5 mph and there is any doubt that the tandem pair can safely stand up, a sliding landing is the best choice. Factors that require a sliding landing include but not limited to: a hot day, fatigue, field elevation, ground conditions or combined weight of the tandem pair. To prepare for a sliding landing the student must lift their legs and put them out in front prior to touch down. A good slide requires a good flare to almost zero rate of descent. The Tandem Instructor sits back in his harness (thus pulling the student back as well) and is prepared to take the landing on his or her feet, but continues to sit back after initial ground contact to a slide on their butt with the student literally sitting in his lap. It is important that the Tandem Instructor sit back on landing so the student will not have a tendency to lean forward at touchdown (which can cause the Tandem Instructor to roll over on top of the student.)
- **Canopy turns to land are limited to 90 degrees or less at or below 500ft:** (This is also now a USPA Basic Safety Requirement.)

## WATER LANDINGS

A water landing is not a likely scenario for a Tandem jump, but it is a possibility. Below is a list of procedures to follow for a Tandem water landing. Since it is best to be prepared, practice the sequence on the ground to get familiar with the order of events.

On any skydive (whether Tandem or sport) made in the vicinity of water, water gear must be worn. If a Tandem jump is made near water, BOTH the Instructor and the student must wear approved water gear.

### Procedure

- Release RSL.
- Disconnect student lower student attachment points and reconnect to student harness.
- Have student inflate their flotation gear.
- The tandem instructor undoes their chest strap.
- Have the student get into a legs up landing position due to depth of water not being known
- Flare and land into the wind.
- If there are high winds, release the main canopy. Under no circumstances should this be performed prior to landing.
- Release student top snaps.
- Push student away.
- The tandem instructor swims out of harness.
- The tandem instructor inflates their flotation gear.

**SECTION 4: MALFUNCTIONS & EMERGENCIES**

CHAPTER 1: RESERVE PROCEDURE

CHAPTER 2: IN AIRCRAFT

CHAPTER 3: EXIT & FREEFALL / DROGUE FALL

## CHAPTER 1 – RESERVE PROCEDURE

### EMERGENCY RESPONSE SEQUENCE

It is very important to take the time to think out and rehearse how to respond to different situations before ever faced with them. Always read the Tandem accident and incident reports to learn from the mistakes of others. This is considered continuing education as a Tandem instructor.

Unusual or emergency situations while performing Tandem jumps require quick assessment and decision making with the proper reactions. It is important to understand the proper sequence of actions required for any situation you may encounter. The addition of the drogue system adds extra procedures, which are different than those you would perform when jumping solo equipment. Refer to Malfunction Procedure Diagram.

### RESERVE PROCEDURES

- Out of sequence deployments
- Total malfunctions
- Partial malfunctions
- Canopy transfers
- **Out-of-sequence deployments:**
  - Deploy the drogue
  - Pull either the left, right or both drogue release handle(s).
  - Assess main canopy condition
  - Perform emergency procedures if required
- **Total malfunctions:**
  - Pull the reserve ripcord handle to full extension
  - Assess reserve canopy condition
- **Partial malfunctions:**
  - Locate and grab both emergency handles
  - Pull the cutaway handle with right hand to full extension
  - Visually ensure a full & clean breakaway. Physically assist if needed
  - Pull the reserve ripcord with the left hand to full extension
  - Assess reserve canopy condition

**NOTE:** The reserve static line (RSL/Skyhook) is a backup system that should not be relied upon. **Always perform full emergency procedures.**

**Canopy transfers:** Intentional canopy transfers are not allowed on the Tandem system.

**If the instructor's left arm is incapacitated, and unable to activate the reserve handle, the RSL may be used with the right hand to deploy the reserve. This is accomplished by:**

- **Disconnecting the RSL snap shackle.**
- **Pull the RSL upwards breaking the Velcro closure.**
- **Continue pulling the RSL (free of Velcro) upward over the shoulder.**



## RESERVE CANOPY

Controlling and steering the reserve parachute is similar to the main parachute except in the following areas.

- The reserve toggles are set up for Tandem Instructor control only.
- There are no secondary toggles
- Be aware that the reserve parachute will open in a deep brake configuration and rocking will likely occur (this is on the VR360 Reserve. The new reserves do not have the “rock and roll” tendency). Releasing the brakes immediately after opening will alleviate this.
- In the event of a Reserve Canopy malfunction. The Tandem Instructor must make every attempt to correct the situation. Reserve Canopy malfunctions, while extremely rare, can still occur. The corrective actions for a Reserve Canopy malfunction are the same as a Main Canopy Malfunction. – Release the brakes, and attempt to gain control through a controllability check.
- In the highly unlikely event that Reserve Canopy malfunction cannot be corrected. The Tandem Instructor must make every effort to land the Reserve Canopy as slowly and softly as possible. PLFs (Parachute Landing Falls) may or may not be incorporated landing in this configuration. It is up to the discretion of the Tandem Instructor, acting as Pilot in Command, to assess the situation and make the most appropriate decision for such a landing.

# MALFUNCTION PROCEDURE DIAGRAM

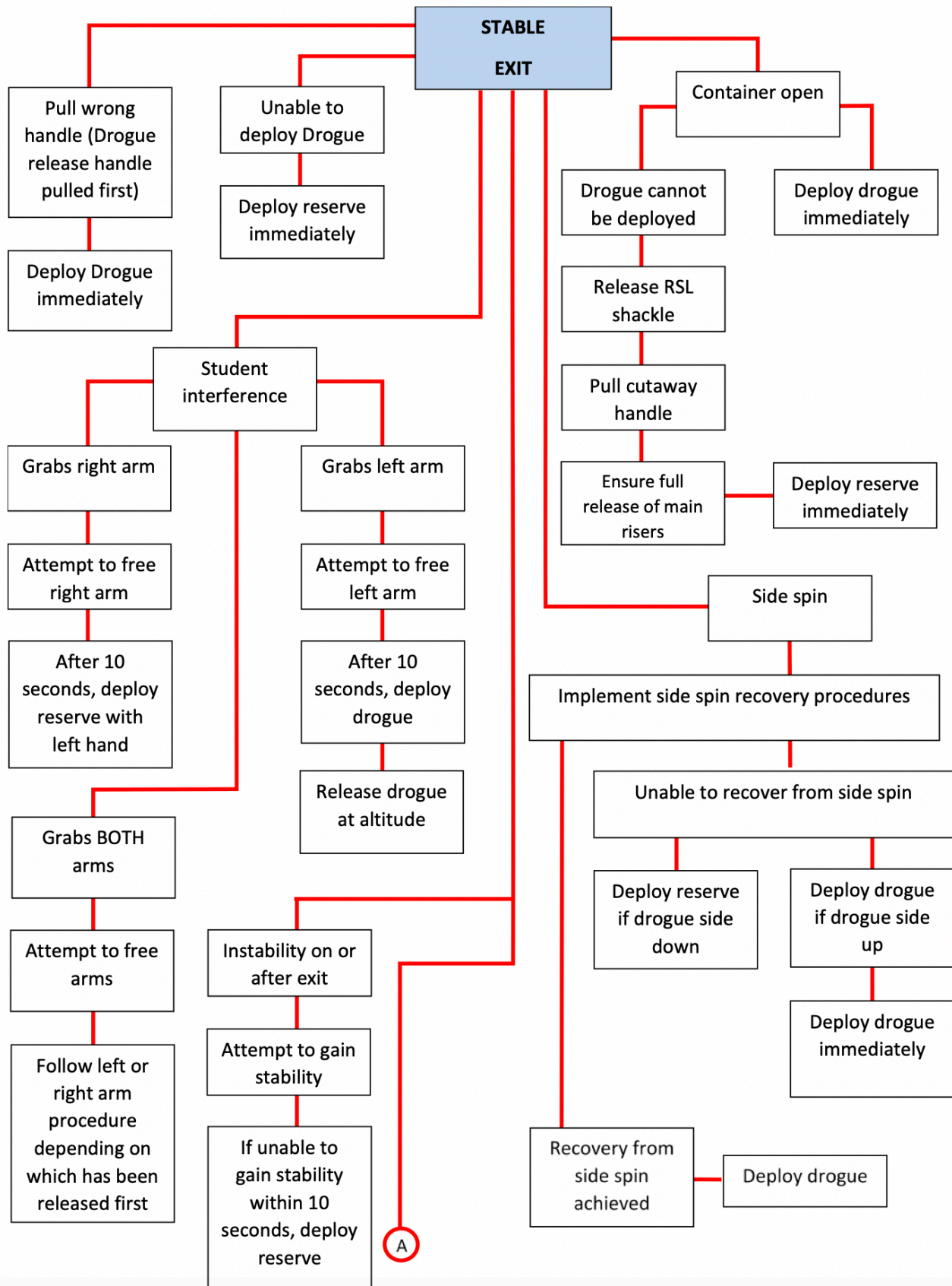

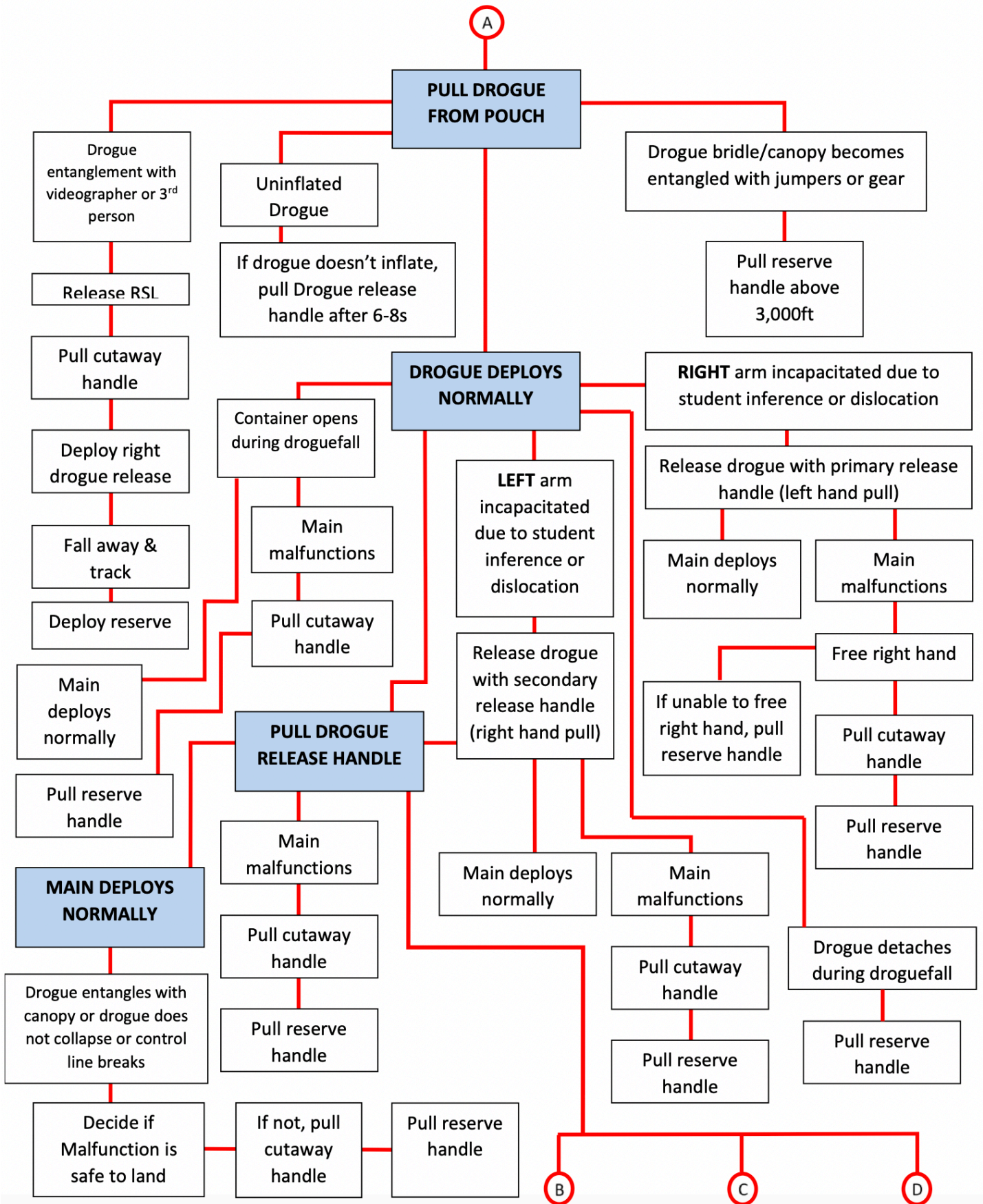

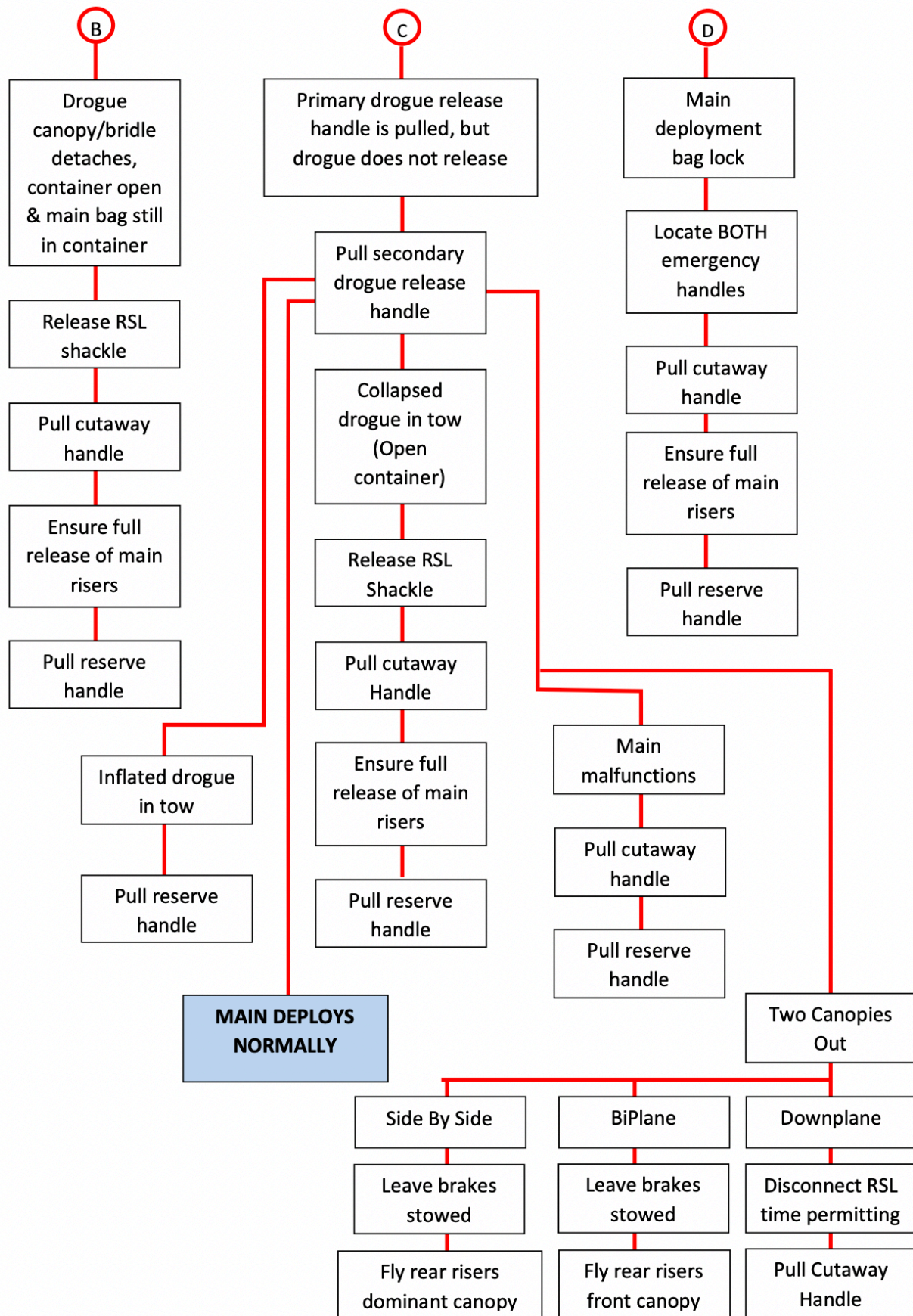

## CHAPTER 2: IN AIRCRAFT

### AIRCRAFT EMERGENCIES

- Below 1500ft (450m), Stable flying aircraft, engine out
- Below 1500ft (450m), catastrophic airframe failure
- 1500ft - 4000ft (450m-1200m)
- 4000ft (1200m) +

Due to differences between Tandem and solo systems, the following procedures are to be followed:

- **Below 1500ft (450m)** - Aircraft engine out or similar: If the aircraft is stable, stay with the aircraft and follow instructions from the pilot. Ensure that the Tandem pair is seated and wearing safety belts.
- **Below 1500ft (450m) (catastrophic aircraft failure):** If the aircraft is on fire, in a spin or a large control surface has been damaged, there is a greater chance of survival by exiting the aircraft. Connect the student with as many attachment points as the situation will allow starting with the upper left. Hold the student with the right arm if needed, exit the aircraft and immediately pull the reserve ripcord with the left hand.
- **1500ft - 4000ft (450m-1200m):** Attach the student, exit the aircraft and immediately pull the reserve ripcord.
- **Above 4000ft (1200m):** Attach the student, exit the aircraft, deploy the drogue and ensure inflation. Immediately pull the drogue release.

### STUDENT REFUSAL

There are two different situations which may arise:

- **The student refuses while still in the aircraft:** If the student decides at any time that they do not want to jump while still in the aircraft, descend with the aircraft, accompanying them to the ground. Once the jump door has closed and the aircraft descent has begun, disconnect the student, and place individual seat belts on the instructor and the student.
- **The student refuses once on the strut or outside of the aircraft:** If the student verbally lets you know they do not want to jump then you must bring them back into the aircraft unless the aircraft door is restrictive in a way that it would be dangerous to re-enter the aircraft (accidental deployment of either parachute system). Once inside the aircraft, follow the procedure above.

## CHAPTER 3: EXIT & FREE FALL/DROGUE FALL

### UNTIMELY CANOPY DEPLOYMENTS

#### PROBLEM:

- **High pull:** Here is the scenario for the most common complication that arises on Tandem jumps where the student knows where the handle is and knows how to pull it: The Tandem pair exits the aircraft. The student panics and pulls the drogue release handle after the Tandem Instructor deploys the drogue and the main deploys instantly. This can endanger anyone exiting with the pair, above and in line with the relative wind, such as a cameraman, since he may inadvertently be directly over the pair as the main deploys unexpectedly.
- **Low pull:** This situation may occur when the student is assigned to pull the secondary drogue release. Following the pull signal the student gropes and has difficulty in finding the secondary drogue release handle. Meanwhile, the Tandem Instructor reaches back for the drogue release handle. So he waits, sure that the student will get it any second. Meanwhile, the delay causes the pair to open below the planned altitude. In the very worst case scenario, the Tandem Instructor reaches back for the primary drogue release handle but cannot find it. He then deploys the reserve - just as the student finally finds the handle and deploys the main.

**REACTION:** On every jump, the Tandem Instructor should throw the drogue and perform practice pulls to both drogue release handles, as well as the reserve ripcord. This simple exercise can eliminate the above mentioned scenario.

### EXIT PROBLEMS

- **Instability following exit:** If the tandem instructor does not maintain or gain stability within 10 seconds, the reserve must be pulled before reaching tandem terminal.
- **Container open before the drogue has been deployed:** Immediately deploy the drogue and expect a main canopy opening.
- **Container open but the drogue cannot be deployed:** Release the RSL shackle and pull the breakaway handle. Ensure full release of the main risers, physically assisting if necessary. Immediately pull the reserve handle.
- **Student grabs the Tandem Instructor's right arm immediately after exit:** Utilize all means necessary to free the right arm. If unable to do so within 10 seconds following exit, pull the reserve ripcord using the left hand.
- **Student grabs the Tandem Instructor's left arm immediately after exit:** Utilize all means necessary to free the left arm. If unable to do so within 10 seconds following exit, deploy the drogue and release it at altitude.
- **Student grabs both the Tandem instructor's arms:** Utilize all means necessary to free any arm. Depending on which arm has been freed, follow the appropriate directions above.
- **Tandem Pair develops into Side Spin:** Implement side spin recovery procedures by making every effort to fly your body and gain stability. If unsuccessful - Bring student's arms in, with Tandem Instructor grasping student wrists and placing them at their hips. Capture student's

legs using Tandem Instructor's legs. Straighten out both bodies removing arch of the spines. Once the Side Spin dissipates, achieve a belly-to-earth orientation, achieve stability and set drogue. If unable to recover from Side Spin and "Drogue Side Up", deploy the drogue to achieve stability. If unable to recover from Side Spin and "Drogue Side Down", activate reserve.

- **WARNING: Never put a wrist mounted altimeter or camera in front of student's face.**

## DROGUE DEPLOYMENT PROBLEMS

- **Drogue release handle pulled before deploying the drogue:**

If container open, deploy the drogue immediately.

- **Drogue extraction difficulty:** Instructor can place right elbow on the side on the container to gain leverage for assisting in extracting the drogue from the pouch.

- **Unable to extract the drogue from the drogue pouch:**

Pull the reserve ripcord within 10 seconds following exit.

- **Drogue has been deployed but is not visible behind tandem pair (stuck in burble):**

After looking over the right shoulder to confirm drogue set and not seeing the drogue deployed above the tandem pair, the tandem instructor should immediately reach back to the drogue pocket with their right hand to confirm that the drogue assembly has been removed from the Spandura pocket. If the pocket is empty, the instructor should reach back above the main container pack tray with their right hand and feel for either the drogue canopy and/or the drogue bridle. If either the drogue canopy or fabric is found, the tandem instructor should grab whatever material presents itself and attempt to deploy it into the relative wind vigorously. If this second drogue deployment attempt is unsuccessful or the tandem instructor cannot locate either the drogue canopy or bridle, the tandem instructor should dip their right shoulder to bring clean air across the tandem pair's back. If this procedure is unsuccessful, the tandem instructor should repeat the process, lowering their left shoulder to bring clean air over the back of the tandem pair. If still unsuccessful in locating and deploying the drogue after 10 seconds, deploy the reserve. If the drogue does deploy using these procedures and is then entangled with either tandem instructor or tandem student, follow the procedure for drogue/bridle entanglement as described (below). If the drogue deploys and is un-inflated/, follow the procedures for un-inflated drogue.

- **Un-inflated drogue immediately after drogue deployment:**

If after 6-8 seconds the drogue does not inflate, immediately pull one of the drogue release handles to initiate main canopy deployment. Expect a longer trap door effect and a slower than normal main canopy opening.

- If unable to open main pack tray (now a Hard Pull On Drogue Release, deploy the reserve after 2 attempts to release the drogue).
- If the main pack tray opens upon initiating main deployment, but does not initiate main canopy deployment (now a Collapsed Drogue In Tow During Main Deployment), release the RSL shackle and pull the cutaway handle. Ensure full release of the main risers, physically assisting if necessary. Immediately pull the reserve handle.

- **Entanglement with drogue canopy (Instructor or Student entanglement):**

Attempt to clear the drogue canopy. If unsuccessful within 10 seconds following exit, immediately

pull the reserve handle.

- **Entanglement with drogue bridle (Instructor or Student Entanglement):** Attempt to clear the drogue bridle. If unsuccessful within 10 seconds following exit, immediately pull the reserve handle.
- **Drogue entanglement with solo skydiver:** Observe altitude of the situation and if the solo skydiver has not cleared within 10 seconds (altitude permitting), proceed with the following steps.
  - Release the RSL shackle
  - Pull the breakaway handle
  - Pull RIGHT SIDE drogue release handle (left side may be substituted if the right side does not release main)
  - Ensure full main canopy and riser release
  - Gain stability & **horizontal separation** (track 4-5 seconds) while maintaining altitude awareness
  - Locate & pull reserve ripcord handle

## DROGUE FALL PROBLEMS

- **Student grabs the Tandem Instructor's right arm during drogue fall:** Utilize all means necessary to free the right arm. If unable to do so, pull the left (Primary) drogue release at a proper altitude. If the drogue does not release after two attempts (now a drogue in tow), immediately pull the reserve handle.
- **Student grabs the Tandem Instructor's left arm during drogue fall:** Utilize all means necessary to free the left arm. If unable to do so, pull the right (Secondary) drogue release at a proper altitude. If the drogue does not release after two attempts (now a drogue in tow), immediately disconnect RSL snap shackle with right hand and deploy the reserve using the RSL lanyard.
- **Student grabs both the Tandem Instructor's arms during drogue fall:** Utilize all means necessary to free any arm. Depending on which arm has been freed, follow the appropriate directions above.
- **Drogue becomes detached during drogue fall:** Locate and pull reserve ripcord handle.
- **Hard pull on drogue release:** Pull each Drogue release handle separately followed by pulling both simultaneously.

## DEPLOYMENT PROBLEMS

- **Drogue/Bridle assembly detaches upon drogue release – Main canopy still in pack tray:** Release the RSL shackle and pull the cutaway handle. Ensure full release of the main risers, physically assisting if necessary. Immediately pull the reserve handle.
- **Main deployment bag lock:** Locate and grab both emergency handles. Pull cutaway handle to full extension and ensure full separation from main canopy and risers. Pull reserve ripcord handle to full extension.
- **Streaming Main Canopy:** Locate and grab both rear risers and pull down simultaneously on both rear risers. Make two attempts to bring the slider down using this technique while maintaining altitude awareness. If unsuccessful, pull cutaway handle to full extension and ensure full separation from main canopy and risers. Pull reserve ripcord handle to full extension.



- **Collapsed drogue in-tow during main deployment:** Release the RSL shackle and pull the cutaway handle. Ensure full release of the main risers, physically assisting if necessary. Immediately pull the reserve handle.
- **Non collapsed drogue during main deployment:** Ascertain whether the main canopy has been damaged by the opening shock. If it has, decide whether it is controllable and safe to land. If it is not safe to land, perform emergency procedures by pulling the cutaway handle, ensuring full release of both main risers, physically assisting if necessary. Immediately pull the reserve handle.
- **Drogue entanglement with the main canopy:** If the drogue entanglement hinders the main canopy opening or controllability, perform emergency procedures by pulling the cutaway handle, ensuring full release of the main risers, physically assisting if necessary. Immediately pull the reserve handle.
- **Tension knots on main canopy:** Release the brakes and counter steer any turn. Use aggressive input via the main risers or control lines on the affected side, in an attempt to clear the tension knots. If unsuccessful, perform emergency procedures by pulling the cutaway handle, ensuring full release of the main risers, physically assisting if necessary. Immediately pull the reserve handle.
- **Broken suspension lines:** Perform controllability check and assess if the canopy can be landed safely. If not, perform emergency procedures by pulling the cutaway handle, ensuring full release of the main risers, physically assisting if necessary. Immediately pull the reserve handle.
- **Broken or nonfunctional primary control lines:** Perform emergency procedures by pulling the cutaway handle, ensuring full release of the main risers, physically assisting if necessary. Immediately pull the reserve handle.
- **Broken or nonfunctional secondary control lines:** Perform controllability check and assess if the canopy can be landed safely. If not, perform emergency procedures by pulling the cutaway handle, ensuring full release of the main risers, physically assisting if necessary. Immediately pull the reserve handle.
- **Canopy fabric damage:** Perform controllability check and assess if the canopy can be landed safely. If not, perform emergency procedures by pulling the cutaway handle, ensuring full release of the main risers, physically assisting if necessary. Immediately pull the reserve handle.
- **Line twists:** Maintaining altitude awareness, attempt to kick out of the line twist, instructing the student to assist if necessary. If unsuccessful, perform emergency procedures by pulling the cutaway handle, ensuring full release of the main risers, physically assisting if necessary. Immediately pull the reserve handle.
- **Line over:** Release the brakes and make two attempts to clear the line over by conducting a steady, even flare movement with both primary toggles. If unsuccessful in clearing the malfunction, or if the main canopy enters an uncontrollable spin, perform emergency procedures by pulling the cutaway handle, ensuring full release of the main risers, physically assisting if necessary. Immediately pull the reserve handle.
- **Two Canopy Out (Bi-Plane):** Attempt to contain the (2nd) deploying canopy, main or reserve, and maintain control of it, ensuring it remains in its deployment bag. If deployment of the second canopy is inevitable, and it results in a stable "Bi-Plane" formation, leave the brakes

stowed on both canopies and make gentle control inputs by pulling down on either of the left or right rear risers of the front canopy to initiate turns. Prepare for a PLF landing if necessary.

- **Two Canopy Out (Side-By-Side):** Attempt to contain the (2nd) deploying canopy, main or reserve, and maintain control of it, ensuring it remains in its deployment bag. If deployment of the second canopy is inevitable, and it results in a stable "Side-By-Side" formation, leave the brakes stowed on both canopies and make gentle control inputs by pulling down on either of the left or right rear riser of the dominant canopy to initiate turn.
- **Two Canopy Out (Downplane):** Attempt to contain the (2nd) deploying canopy, main or reserve, and maintain control of it, ensuring it remains in its deployment bag. If deployment of the second canopy is inevitable, and it results in a "downplane" formation, disconnect the RSL (if altitude permits) and perform emergency procedures by pulling the cutaway handle, ensuring full release of the main risers, physically assisting if necessary.

**In any emergency scenario that requires a cutaway of the main canopy:**

- If time and altitude permit, attempt to capture the legs of the tandem student before initiating a cutaway.
- If time and altitude permit, request that your student arch, grab the main lift web of their harness with their hands and tilt their head back.
- These additional body position procedures should not prevent performing emergency procedures in a timely manner.

**SECTION 5: STUDENT TECHNIQUES**

CHAPTER 1: STUDENT SKILLS

CHAPTER 2: OTHER ACTIVITIES



## CHAPTER 1: STUDENT SKILLS

The following points will be presented in logical order as they would happen on a jump and they are the minimum to be included. You may choose to include a few extra points from the progression list to fulfill your targeted learning objectives for freefall transition.

Order of presentation:

- Equipment
- Exit practice (including aircraft procedures and emergencies)
- Freefall
- Canopy control
- Student task list

### EQUIPMENT

Provide Instruction on the following items:

- Student accessories: Retrieve and display the following optional items prior to gearing up: altimeter, jumpsuit, soft helmet, and goggles (mandatory) are a must. Select a tight suit. This will reduce extra drag from your student, aiding stability after exit. A soft helmet is recommended as it is less of a risk if the Tandem Instructor were to strike the student's head during the jump.
- Student harness: Due to the complexity of properly adjusting the student harness, never allow the student to adjust their harness entirely on their own. They certainly may step into the harness and fasten the chest strap, but the remainder of the adjusting should be done by the Tandem Instructor. Explain the problem of the blood flow being reduced at the legs and the shoulders and the importance of proper harness adjustment. It is practically impossible for the

### EXIT PRACTICE

Go to the plane or aircraft mock-up early, and practice in-flight procedures. The in-flight instruction should include: climbing into the aircraft and seating position, what to do on the way to altitude, the hook-up procedures and the climb out and launch from the airplane. To practice, get into the plane and run through the whole jump sequence once or twice, including an exit with the student's harness attached and tightened down. Review the body position the student should assume for the exit launch and freefall.

### EXIT & FREEFALL POSITIONS

Demonstrate and explain the proper body position for exit and freefall to your student. Every stable exit and drogue deployment begins on the ground with thorough training of the student in the proper body position. Have the student lie down and practice the correct freefall position. Several minutes of practice here will make all the difference on exit and freefall. Exit requirements from aircraft to aircraft may cause a variance in the position but the basics remain the same.

- Hands holding onto the side of harness. (main lift webs)
- Elbows back and alongside of body
- Head back
- Torso arched (pelvis forward)
- Feet together

We recommend this position and emphasize the importance of keeping the arms IN on exit to reduce the likelihood of door contact. Remember that it is far easier to control a student whose arms are close to the body.

**Arm extension following exit:** This is simply a regular RW box body position with the arms out and comfortably bent. It should also be practiced in the prone position including the signal you intend to give for release and attaining this position. The signal can be a tap on the shoulders, and/or a shout in the ear. NEVER reach around in front of the student for any reason.

It is important to instruct the student never to grab your arms or reach behind them at any time during the jump. Or simply tell them if they feel the need to grab something, to just grab the harness just like trained for exit.

## CANOPY CONTROL

**Location of steering toggles:** After opening have the student look up to the risers and visually locate the steering toggles. Demonstrate the release of the brakes with mention of the increasing wind speed as the canopy approaches full flight. The Tandem Instructor should use the student toggle position to release the brakes. Perform a canopy controllability test, turn both directions and flare the canopy. Have the student slip their hands into the toggle and grasp firmly. Advise them to follow your commands and assist in control maneuvers.

**Steering the canopy:** While the student is assisting in controlling the canopy, have them perform and identify the following flight modes:

- **Full flight:** Most students tend to pull on the toggles all the time. They must be taught to consciously leave the hands all the way up for full flight.
- **Turns:** Have the student look in direction (and below) of the intended turn, checking for other canopies, and then pick out a ground heading to turn to. Practice turns in both directions. The student should try both flat and spiral turns to recognize the difference in speed and descent of the canopy. Inform the student that no countering is necessary to stop a turn, simply return the toggle to the same level as the opposite one and wait for the turn to settle.
- **Braking:** Have the student pull down on both toggles from full flight position. Student should listen and feel the change in wind speed and noise. Mention that the canopy will slow down a lot and that is why braking is done on landing. Explain to the student the difference in braking and flaring the canopy for landing. Gradual braking slows the canopy but with an increase in descent, while flaring slows the canopy with an increase in lift.

**Flaring the canopy:** This practice must be performed prior to entering the landing pattern. Have the student practice flaring the canopy upon your command. The student should follow these steps:

- Have both arms raised all the way up in the full flight position.
- Start flare immediately upon Tandem Instructor's command.
- Flare symmetrically and fully in one smooth downward motion.
- Ensure a complete flare with arms extending downward until achieving an effective flare..
- Hold this position until landing or commanded otherwise.

This flare drill should be practiced 3-4 times to enable the student to become familiar with the procedure. You should inform the student to remain relaxed, yet ready to respond to the flare commands you will be giving upon the landing approach. Let the student know that the approach speed may seem quick and reassure them that the canopy will slow down when flared. Allow the student to assist with the landing ONLY if they have demonstrated competent skill.

**Landing approach:** Discuss canopy approach to the landing area; point out the pattern or flight path you intend to take and at what altitude you plan to be at each turning point. Point out the direction of the wind and the expected landing point.

## **EXIT & FREEFALL POSITIONS**

- Get into harness with assistance.
- Perform climb out with Tandem Instructor attached.
- Attain correct position prior to exit.
- Perform arm extension upon Tandem Instructor's command.
- Grasp steering toggles upon command.
- Perform turns, braking, full flight and perhaps flaring upon Instructors command.
- Prepare for landing on Tandem Instructor's command.

## CHAPTER 2: OTHER ACTIVITIES

These guidelines are **not optional**. They must be followed, or the Tandem Instructor and Tandem rig owner will be in violation of the User Agreement under which Tandem jumping is operated and will consequently no longer be allowed to legally perform Tandem Jumps.

### PARTICIPANTS QUALIFICATIONS

For any relative work (RW) skydiver to accompany a Tandem pair, one of these three criteria must be met:

- 
- RW skydiver must have a minimum of 500 relative work skydives
- RW skydiver must be either a current Tandem Instructor or a current AFF jumpmaster
- Have 300 relative work skydives and pass the skills set of the USPA coach rating
- 

In addition to the above, the following must be met

- RW skydiver must have made at least 100 RW jumps in the last year.
- Cameramen must have at least 100 camera jumps.

### HAND-CAMERA PROCEDURES

#### Minimum Requirements for performing hand camera (Handcam) tandem skydives.

Due to the potential for distraction and the added complexity during tandem student hook-up and exit, the following are the minimum recommendations for instructors who wish to use a Handcam set up:

- Minimum 200 post-probation tandem skydives acting as Tandem Instructor or has attended an approved Handcam training program by an examiner. Questions regarding approved programs should be referred to the current UPT Tandem Program Director.
- The first tandem skydive made after a seasonal layoff as tandem instructor should not be made with a Handcam.
- The Tandem Instructor should demonstrate and practice on the ground Emergency Procedure handle activations with a mock student attached and full gear donned.
- Before taking a first time tandem student with a Handcam, the tandem instructor should make 2 jumps with a currently rated Tandem Instructor to feel how it effects flying and to be comfortable with the operation of the camera
- The use of Handcam still requires the Tandem Instructor to perform post drogue deployment handles checks.
- The use of helmet mounted cameras, telescopic camera mounted poles, or any fixed camera pole is forbidden.

### RW TANDEM BRIEFING

- If the Tandem Instructor does allow an RW skydiver to accompany them on a jump, a briefing **MUST** take place before covering these points:
- Never let anyone who is not a skilled RW skydiver accompany a Tandem, regardless of qualifications. This decision is solely at the discretion of the Tandem master.
- Never pass directly over or under the Tandem pair during exit, drogue fall and deployment.
- Always leave room for drogue deployment.
- Always approach the Tandem pair cautiously and on level within sight of the Instructor. The

Tandem pair has very little ability to change drogue fall velocity or to move horizontally and therefore cannot take evasive action.

- If grips are taken, they MUST be on the student and NOT on the Tandem Instructor.
- Accompanying RW skydiver must not attempt to open their main canopies in proximity to the Tandem pair. A minimum of 1000ft (300m) vertical separations required to avoid collision situations.
- RW must cease by 6500ft (1981M) AGL.
- The RW jumper must clear the airspace of the tandem pair prior to the tandem pair initiating main canopy deployment.
- The RW jumper must be briefed on the emergency procedure for "Drogue Entanglement with solo skydiver."

## **CANOPY SEPARATION REQUIREMENT**

A minimum separation of 100ft (30m) is required under canopy at all times.

**CRW IS POSITIVELY BANNED ON ALL TANDEM JUMPS UNDER ANY AND ALL CIRCUMSTANCES**

**WINGSUIT FLYBYS ARE POSITIVELY BANNED ON ALL TANDEM JUMPS UNDER ANY AND ALL CIRCUMSTANCES**



**SECTION 6: CARE & MAINTENANCE**

**CHAPTER 1: CARING FOR YOUR SIGMA**



## CHAPTER 1: CARING FOR YOUR SIGMA

To extend the life of the harness and container system, regularly scheduled inspections and maintenance must be performed at once per month. Abnormal or harsh conditions and frequent use will shorten the life expectancy of the equipment. It is the responsibility of the owner and operator to ensure that equipment remains in optimal working order. Any concerns should be addressed with the manufacturer or an appropriately rated rigger.

### RECOMMENDED COMPONENT LIFESPANS

The following recommendations have been established based on the estimated lifespan of Sigma Tandem components. Ensure that an appropriately rated rigger determines if the components are in an airworthy condition.

- Replace main canopy suspension lines every 350-500 jumps as needed.
- Replace main canopy every 1400 – 1600 jumps.
- Replace main risers every 600 jumps.
- Replace drogue centerline every 300 jumps.
- Replace the lower Drogue Bridle every 300 jumps
- Replace drogue every 600 jumps.

### RESERVE COMPONENT LIFESPANS

- Reserve canopy is limited to 25 uses, 40 pack jobs or 20 years in service, whichever comes first.
- Reserve Pilot Chute limited to 25 uses.
- R.S.L and Skyhook limited to 25 uses.

Once a component limit has been reached, it is no longer certified for use. If further use is intended, it must be returned to the manufacturer for possible recertification.

### INSPECTING YOUR SIGMA

Gear inspections should cover ALL parts of your harness and container system, while paying particularly close attention to these areas:

- **Cutaway System:** Refer to the 3-Ring section in this chapter for detailed information on inspecting the canopy releases.
- **Reserve System:** This includes the reserve ripcord, closing loop, pins, handle, housing, container and associated sewing. You should NOT attempt any repairs or modifications to ANY of these items unless you are an appropriately rated rigger. You can, however, identify smaller problems before they become more severe. Some items to look for would include damage to the reserve ripcord, frayed or worn closing loop, frayed stitching on the container, etc.
- **Harness:** The harness should be inspected periodically for broken stitching or frayed webbing.
- **Main Container:** Inspect the plastic stiffeners in the container flaps and have replaced any that are broken. Replace any grommets that are deformed, nicked, damaged, or that are pulling out of their setting.

- **Drogue Chute:** TBA
- **Closing Loop:** The main container closing loop is made of spectra suspension line. This loop is subject to wear and should be replaced upon the first sign of damage.
- **Hook and Loop Fastener:** Hook and loop fastener has many applications within skydiving. Even though it can eventually wear out, there exist few materials that can compete against it with regard to its flexibility, adaptability, and wide variety of applications. The “hook” portion of hook and loop fastener often attracts dirt, bits of grass, hair and other debris. You can clean the hook portion using a fine-toothed comb. The “loop” section generally remains clean but the nylon fibers sometimes tend to get pulled out of place. When you find that your hook and loop fastener is losing its adhesive qualities, replace it.

### 3 RING RELEASE SYSTEM

- Yearly or as needed, operate the 3-Ring release system on the ground. Extract the cable completely from the housings and disconnect the risers.
- While the system is disassembled, closely inspect it for wear. Check the white locking loops (the ones that pass over the smallest ring and through the grommet) to be sure they are not frayed.
- Check the hook and loop fastener on the cutaway handle and main lift web to be sure it is clean and adequately holds the handle.
- Check the cable ends for a smooth finish. The ends are finished at the factory to have a smooth, tapered surface. This prevents the cable from hanging up in the loop. Check the cable ends and consult a rigger or the manufacturer if a burr or “hook” is present.
- Check the stitching, including that which holds the large rings to the harness.
- Check that all 3-Ring release housings are firmly clamped (behind right ring cover and under yoke).
- Take each riser and vigorously twist and flex the webbing near where it passes through each ring. The idea is to remove any set or deformation in the webbing. Do the same thing to the white loop.
- Check the housings for dents or other obstructions. Use the cable to do this.
- Clean and lubricate the release cable with a silicone spray. Spray on a paper towel and firmly wipe the cable a few times. A thin, invisible film should remain, too much will attract grit and dirt.
- Inspect the end fittings at the end of each housing for damage.
- If any wear is found, consult the United Parachute Technologies or qualified rigger before using the system.
- Reassemble the system

## SOURCES OF EQUIPMENT DEGRADATION

Your Sigma is manufactured primarily from nylon. Nylon is very durable, yet it is still susceptible to damage from several sources.

- **Sunlight:** The ultraviolet rays in sunlight quickly and permanently weaken nylon. Keep equipment out of direct sunlight whenever possible. Structural weakening of nylon is not immediately noticeable.
- **Acids:** Hangar floors, dirty car trunks and similar areas are where acids can be found. If contamination does occur, immediately and thoroughly wash the affected with plenty of warm soapy water. Baking soda may quickly neutralize most acids as an interim step prior to washing. If acid damage occurs or is suspected, an appropriately rated rigger must thoroughly inspect the equipment.
- **Oils and Grease:** Most petroleum compounds do not weaken nylon; they simply stain it. Warm, soapy water or isopropyl alcohol may remove such stains.
- **Water:** Water will not structurally damage your equipment however, prolonged agitation in fresh water weakens webbing or may cause some fabric and tape colors to bleed. Salt water may damage nylon and cause hardware to corrode if not immediately and thoroughly washed off with plenty of fresh water.
- **Soil:** Brush off the soil after it has dried and gently wash with warm soapy water. Make sure that the soil is not on or in components.
- **Sand:** Sand will weaken and cut webbing and fabrics of all types. Prolonged exposure to sand will shorten the life of the entire parachute assembly.
- **Abrasion:** Nylon will be damaged if dragged over concrete or other rough surfaces. Do not drag any part of the container system while transporting or packing.
- **Perspiration:** Minimize exposure to sweat while using or handling the container system.

## REPLACEMENT PARTS

Uninsured United Parachute Technologies, LLC supplies replacement parts for your Sigma Tandem System. When ordering parts, include the serial number and date of manufacture of your equipment, found on the container data label, so the proper items can be quickly supplied. Refer to the included illustrated parts catalogue.

**ILLUSTRATED PARTS LIST**



54" DROGUE (WHITE) P/N: 032-001-001  
60" DROGUE (WHITE) P/N: 032-001-003

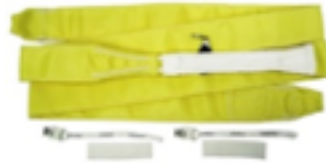

54" DETACHABLE LOWER BRIDLE P/N: 050-005-001  
60" DETACHABLE LOWER BRIDLE P/N: 050-005-002



54" DROGUE CENTERLINE P/N: 032-015-006  
60" DROGUE CENTERLINE P/N: 032-015-002



RECOIL RIPCORD- COMPLETE ASSEMBLY  
P/N: 032-017-006



RECOIL RIPCORD  
P/N: 032-017-005



ORANGE DROGUE RELEASE HANDLE P/N: 032-017-008  
BLUE DROGUE RELEASE HANDLE P/N: 032-017-008



RECOIL RIPCORD PIN  
P/N: MIS-H-PINMTVIII



SIGMA DISC ASSEMBLY  
P/N: 032-017-018



SIGMA DISC COVER  
P/N: 032.-017-001



MAIN DEPLOYMENT BAG – SIGMA 13 P/N: 026-002-001  
MAIN DEPLOYMENT BAG – SIGMA 12 P/N: 026-002-002



25" MAIN RISERS – VELCROLESS P/N: 028-007-003  
22" MAIN RISERS – VELCROLESS P/N: 028-007-004



MAIN TOGGLE-VELCROLESS P/N: 030-002-002  
SECONDARY MAIN TOGGLE-VELCROLESS P/N: 030-003-004

SIGMA TANDEM MANUAL



RESERVE TOGGLE-RED  
P/N: 029-001-002



SPECTRA RESERVE RIPCORD 23.5"  
P/N: 024-021-003



RESERVE RIPCORD MARINE EYE 24.5"  
P/N: 024-011-001



CUTAWAY HANDLE  
P/N: 023-002-001



SPLIT R.S.L.  
P/N: 025-003-003



SKYHOOK LANYARD  
P/N: 025-009-002



UNIVERSAL LANYARD  
P/N: 025-009-001



RESERVE PILOT CHUTE  
P/N: 022-001-000



RESERVE DEPLOYMENT BAG-SIGMA 13 P/N: 027-010-005  
RESERVE DEPLOYMENT BAG-SIGMA 12 P/N: 027-010-004



SKYHOOK COVERS  
P/N: PLAST-RETRO



SAFETY STOW LOOP  
P/N: 027-005-002



STUDENT HARNESS Y STRAP  
P/N: 043-001-005



JACK THE RIPPER HOOK KNIFE  
P/N: 045-004-002



STUDENT HARNESS P/N: 043-001-001  
XS STUDENT HARNESS P/N: 043-007-001



RESERVE PIN FLAP LEXAN WINDOW  
P/N: 008-006-017

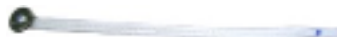

SIGMA MAIN CLOSING LOOP  
P/N: 031-003-001

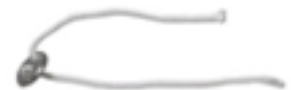

RESERVE CLOSING LOOP  
P/N: 031-002-001

## LINE TRIM CHART FOR

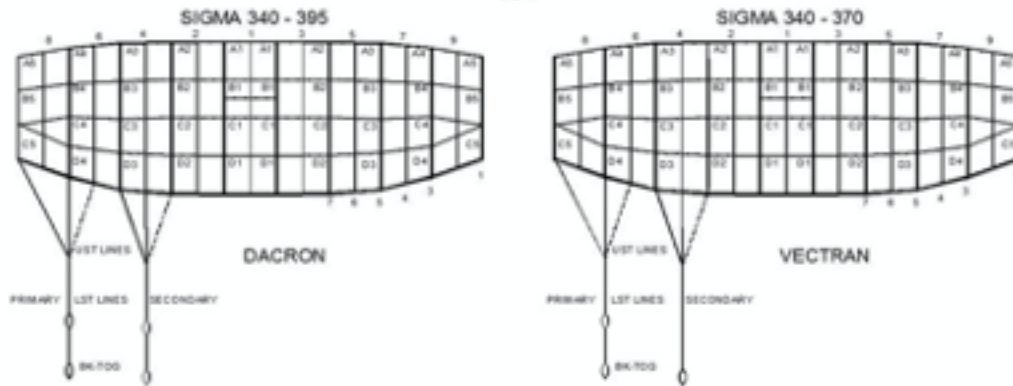

	Measurement in Inches					Measurement in Centimeters				
	SG-340	SG-340	SG-370	SG-370	SG-395	SG-340	SG-340	SG-370	SG-370	SG-395
	Vectran	Dacron	Vectran	Dacron	Dacron	Vectran	Dacron	Vectran	Dacron	Dacron
A1	190 7/8	193 7/8	202 1/4	202 1/4	209	492.5	492.4	513.7	513.7	530.8
A1-B1	3.5/8	3.5/8	3.7/8	3.7/8	4	9.3	9.2	9.7	9.7	10.0
A1-C1	13.1/8	13.1/8	13.3/4	13.3/4	14.1/4	33.4	33.3	34.9	34.9	36.1
A1-D1	24.3/4	24.3/4	25.7/8	25.7/8	26.3/4	62.8	62.9	65.7	65.7	67.9
A2	190 7/8	193 7/8	202 1/4	202 1/4	209	492.4	492.4	513.7	513.7	530.7
A2-B2	3.5/8	3.5/8	3.7/8	3.7/8	4	9.3	9.2	9.8	9.8	10.1
A2-C2	13.1/8	13.1/8	13.3/4	13.3/4	14.1/8	33.2	33.3	34.8	34.8	35.9
A2-D2	24.5/8	24.5/8	25.3/4	25.3/4	26.5/8	62.5	62.5	65.4	65.4	67.6
A3	194	194	202 3/8	202 3/8	209 1/8	492.8	492.8	514.0	514.0	531.1
A3-B3	3.5/8	3.5/8	3.3/4	3.3/4	4	9.2	9.2	9.7	9.7	10.0
A3-C3	12.7/8	12.7/8	13.1/2	13.1/2	13.7/8	32.6	32.7	34.2	34.2	35.3
A3-D3	23	23	24.1/8	24.1/8	25	58.6	58.6	61.3	61.3	63.4
A4	194	194	202 3/8	202 3/8	209 1/8	492.8	492.8	514.0	514.0	531.1
A4-B4	3.7/8	3.7/8	4	4	4 1/8	9.8	9.8	10.2	10.2	10.5
A4-C4	11.5/8	11.5/8	12.1/8	12.1/8	12.1/2	29.5	29.5	30.9	30.9	31.9
A4-D4	20.1/8	20.1/8	21.1/8	21.1/8	21.7/8	51.2	51.1	53.6	53.6	55.4
A5	194 1/4	194 1/4	202 5/8	202 5/8	209 3/8	493.5	493.4	514.8	514.8	531.9
A5-B5	4.3/8	4.3/8	4.5/8	4.5/8	4.3/4	11.2	11.1	11.7	11.7	12.1
A5-C5	12.1/8	12.1/8	12.3/4	12.3/4	13.1/8	30.8	30.8	32.2	32.2	33.3
LST-P	131 1/2	131 1/2	137	137	143 1/2	334.0	334.0	348.0	348.0	360.5
AS-LST1	8 1/4	8 1/4	8 1/2	8 1/2	8 3/4	21.0	21.0	21.5	21.5	22.2
AS-LST2	8 3/4	8 3/4	9	9	9 1/4	22.3	22.2	22.7	22.7	23.5
AS-LST4	13.5/8	13.5/8	14	14	14 1/2	34.7	34.6	35.7	35.7	36.9
LST-S	154 3/4	156 3/4	161 1/8	162 1/2	167 1/4	393.0	397.3	409.1	361.8	373.9
AS-LST5	32 1/4	33.1/8	33 1/4	33 1/2	34	81.9	83.3	84.5	84.4	85.5
AS-LST6	33.5/8	34.1/2	34.5/8	35	35.3/8	85.3	86.8	88.1	87.9	89.2
AS-LST7	38 1/2	39.3/8	39.3/4	40.1/8	40.3/4	97.8	99.2	101.1	101.0	102.7
B STAB SLK	1	1	1	1	1	2.5	2.5	2.5	2.5	2.5
C STAB SLK	1 1/2	1 1/2	1 1/2	1 1/2	1 1/2	3.8	3.8	3.8	3.8	3.8
BK-TOG-P*	22 1/4	22 1/4	23	23 1/2	24 3/8	56.5	56.5	58.6	59.8	61.8
BK-TOG-S*	N/A	18 1/4	N/A	19 3/8	20	N/A	46.4	N/A	49.2	50.8
Canoe Slider w/ 4 Grommets	16 1/2" Chord 40 3/8" Span 2 channels	16 1/2" Chord 40 3/8" Span 2 channels	16 1/2" Chord 40 3/8" Span 2 channels	16 1/2" Chord 40 3/8" Span 2 channels	19 1/2" Chord 54" Span 2 channels	41.9 Chord 102.6 Span 2 Channels	41.9 Chord 102.6 Span 2 channels	41.9 Chord 102.6 Span 2 channels	41.9 Chord 102.6 Span 2 channels	49.5 Chord 137.2 Span 2 channels

\*Due to development methodology, the trashed BK-TOG dimensions may not scale

All line trim charts are reproduced with permission from Performance Designs, Inc. It is advisable to check directly with Performance Designs for any updates or changes to the information contained within the charts.

## MEASURING THE SIGMA DOME SLIDER

Fold the slider in half front to rear forming a fold from side to side.  
For the spanwise dimension: Pull taut from side to side and measure the slider  
from one side to the other side across the fold.

For the 1/2 Chordwise dimension: Pull taut from the fold to the edge across  
the center and measure the slider from the fold to the edge.

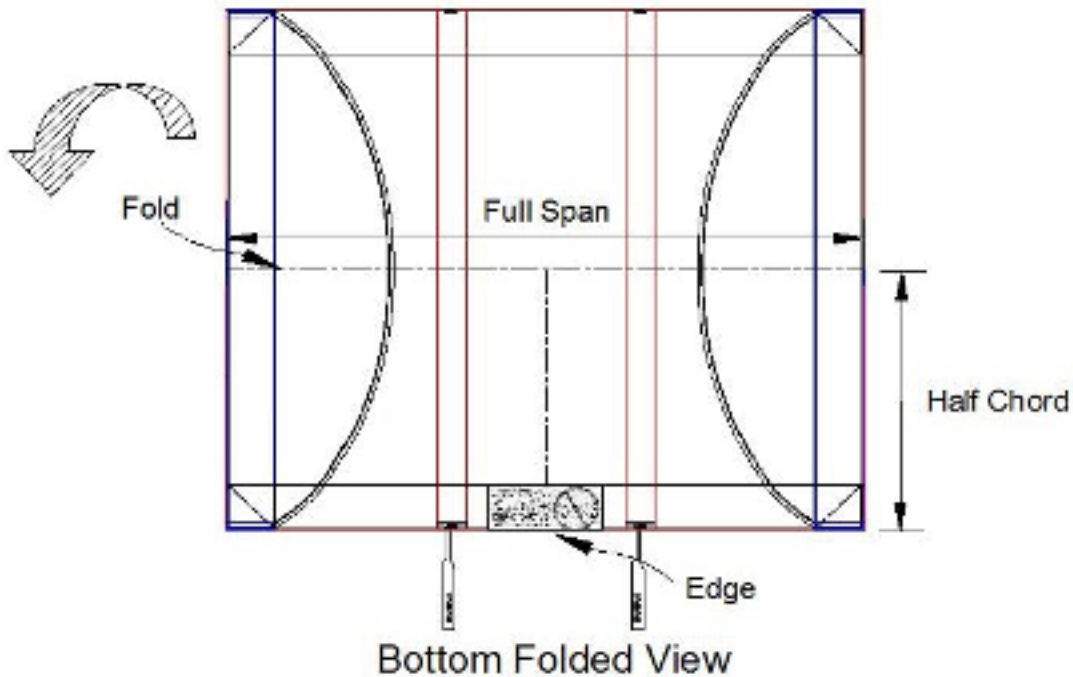



## SIGMA 2 RESERVE CANOPY TECHNICAL INFORMATION

MODEL	SR-340	SR-370
Size (sq ft)	340	370
Chord (ft)	11.63	12.13
Span (ft)	29.28	30.55
Aspect Ratio	2.5: 1	2.5: 1
Weight (lb)*	12.5	13.1
Pack Volume (cu in)*	1,036	1,104
Min FAA suspended weight limit (LB)	200	200
Max FAA suspended weight limit (lb)	550	550
TSO Approval	C23f	C23f
Max Deployment Speed (keas)	175	175

\* Variations of 10% or more are common due to temperature, humidity, material tolerances, and packing technique.

SR-340	Averaged Opening Distance Results Per PIA TS-135 Paragraph 4.3.8.1.(f)			
	TEST SPEED			
TEST WEIGHT	60 KEAS	85 KEAS	MPOS x 80% 140 KEAS	MPOS 175 KEAS
MinOW - 200lb	383	390	322	362
AvOW - 375lb	499	429	408	390
MaxOW - 550lb	526	341	397	440
All results given in distance (feet)				

SR-370	Averaged Opening Distance Results Per PIA TS-135 Paragraph 4.3.8.1.(f)			
	TEST SPEED			
TEST WEIGHT	60 KEAS	85 KEAS	MPOS x 80% 140 KEAS	MPOS 175 KEAS
MinOW - 200lb	347	319	367	299
AvOW - 375lb	561	563	428	336
MaxOW - 550lb	460	514	448	354
All results given in distance (feet)				

<b>SR-340 TRIM DIFFERENTIALS BETWEEN LINE GROUPS (inches)</b>					
	<u>1</u>	<u>2</u>	<u>3</u>	<u>4</u>	<u>5</u>
A-B	3.13	3.13	2.86	2.44	2.25
A-C	11.8	11.86	11.38	10.33	9.13
A-D	24.64	24.61	23.80	21.87	19.14
A5-UST	<u>UST-1</u> 9.71	<u>UST-2</u> 5.82	<u>UST-4</u> 6.42	<u>UST-6</u> 15.14	<u>BK-TOG</u> 27.12

<b>SR-370 TRIM DIFFERENTIALS BETWEEN LINE GROUPS (inches)</b>					
	<u>1</u>	<u>2</u>	<u>3</u>	<u>4</u>	<u>5</u>
A-B	3.26	3.26	2.98	2.54	2.35
A-C	12.41	12.38	11.89	10.79	9.53
A-D	25.75	25.71	24.87	22.85	19.99
A5-UST	<u>UST-1</u> 10.00	<u>UST-2</u> 5.34	<u>UST-4</u> 5.57	<u>UST-6</u> 15.35	<u>BK-TOG</u> 30.01

# LINE TRIM CHART SR-340, 370

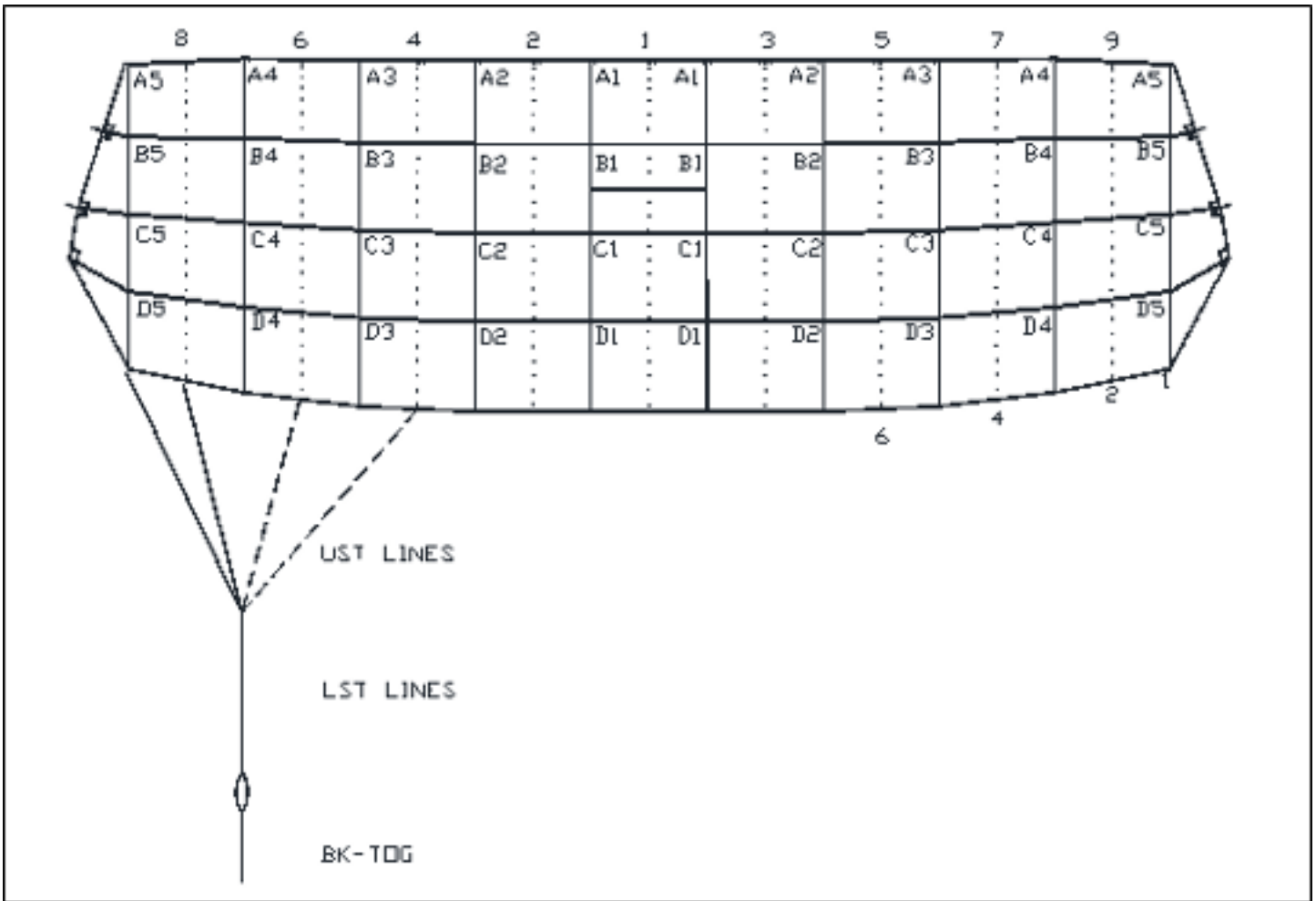

	Inches	Inches		Centimeters	Centimeters
	SR-340	SR-370		SR-340	SR-370
A1	184 3/8	192		468.4	487.6
A1-B1	3 1/8	3 1/4		8.0	8.3
A1-C1	11 7/8	12 3/8		30.2	31.5
A1-D1	24 5/8	25 3/4		62.6	65.4
A2	184 1/2	192 1/8		468.7	487.9
A2-B2	3 1/4	3 1/4		8.0	8.3
A2-C2	11 7/8	12 3/8		30.1	31.4
A2-D2	24 5/8	25 3/4		62.5	65.3
A3	184 3/4	192 3/8		469.3	488.6
A3-B3	2 7/8	3		7.3	7.6
A3-C3	11 3/8	11 7/8		28.9	30.2
A3-D3	23 3/4	24 7/8		60.5	63.2

SIGMA TANDEM MANUAL

A4	185	192 3/4		470.0	489.4
A4-B4	2 1/2	2 1/2		6.2	6.5
A4-C4	10 3/8	10 3/4		26.2	27.4
A4-D4	21 7/8	22 7/8		55.5	58.0
A5	185 3/8	193		470.7	490.3
A5-B5	2 1/4	2 3/8		5.7	6.0
A5-C5	9 1/8	9 1/2		23.2	24.2
A5-D5	19 1/8	20		48.6	50.8
LST	125 1/2	130 3/8		318.6	331.0
A5-UST1	9 3/4	10		24.7	25.6
A5-UST2	5 7/8	6		14.8	15.2
A5-UST4	6 3/8	6 5/8		16.3	16.8
A5-UST6	15 1/8	15 5/8		38.5	39.8
B STAB SLK	1	1		2.5	2.5
C STAB SLK	1 1/2	1 1/2		3.8	3.8
D STAB SLK	2	2		5.1	5.1
BK-TOG	21 1/8	28 3/8		53.5	72.1
Flat Slider (Hole in Center)	32	33		76.2 Chord	76.2 Chord
	39	40		91.44 Span	91.44 Span
*Due to development methodology, the finished BK-TOG dimensions may not scale					



(Weight is approximate, slight variations in weight may result based on main canopy selection and line type.)

Complete System Weight: 50 lbs (22.5 kg)

Main Canopy Fitting: SG-395 Firm  
SG-370 Ideal  
SG-340 Soft

Reserve Canopy Fitting: VR-360 Ideal  
SR-370 Firm

Complete System Weight: 48 lbs (22kg)

Main Canopy Fitting: SG-340 Ideal

Reserve Canopy Fitting: VR-360 Ideal  
SR-370 Firm  
SR-340 Soft

**Approved AADs for both Sigma and Micro Sigma**

	<u>Arming</u>	<u>Activation</u>	<u>De-Arming</u>
Vigil	150 ft	2050 ft	150 ft
Vigil 2	"	"	"
Vigil 2+	1000 ft	"	"
Cypres 2	3000 ft	1900 ft	130 ft
MM2	2950 ft	2000 ft	330 ft

Verify with the specific AAD manufacturer for accurate altitudes. This chart should be used as a reference only.

**Max Operating Weight: 500 lbs (226.5 kg)**  
**With SR Reserve: 550 lbs (249.5 kg)**

**Maximum Student Weight Calculation:**

Max System Weight: 500 lbs (226.5 kg)  
or 550 lbs (249.5 kg)  
Sigma System Weight: 50 lbs (22.5 kg)  
Student Harness Weight: 8 lbs (3.5 kg)

Tandem Instructor Weight: (\_\_\_\_\_)

**Maximum Student Weight:** \_\_\_\_\_

*(Maximum Student Weight is calculated by subtracting Sigma System Weight, Student Harness Weight and Tandem Instructor Weight from 500 lbs (226.5 kg) or 550 lbs. (249.5 kg) depending on the reserve that is being used in the system. The remaining amount is the Maximum Student Weight.)*

**Max Operating Weight: 500 lbs (226.5 kg)**  
**With SR Reserve: 550 lbs (249.5 kg)**

**Maximum Student Weight Calculation:**

Max System Weight: 500 lbs (226.5 kg)  
or 550 lbs (249.5 kg)  
Sigma System Weight: 48 lbs (22 kg)  
Student Harness Weight: 8 lbs (3.5 kg)

Tandem Instructor Weight: (\_\_\_\_\_)

**Maximum Student Weight:** \_\_\_\_\_

*(Maximum Student Weight is calculated by subtracting Sigma System Weight, Student Harness Weight and Tandem Instructor Weight from 500 lbs (226.5 kg) or 550 lbs. (249.5 kg) depending on the reserve that is being used in the system. The remaining amount is the Maximum Student Weight.)*

# DROGUE KILL LINE CALIBRATION

INSTRUCT-036 REV 0

Page 1 of 4

6/14/2012

UNINSURED **UNITED PARACHUTE TECHNOLOGIES, LLC.**



## Drogue Kill Line Calibration

How to check if your Drogue Kill Line is the correct length:

For this system to work correctly, a precise relationship between the length of the drogue bridle and the length of the kill line must be maintained.



To check this relationship:  
Anchor the rapid link at the deployment bag end of the drogue bridle.

Both the drogue bridle and kill line should be connected to this link.

Extend the drogue bridle fully.



**Note:**

This applies to both Kevlar and black Type 12 drogue bridles.

## ENGINEERING DEPARTMENT

1645 LEXINGTON AVENUE ♦ DELAND FL 32724-2106 ♦ TELEPHONE +1 386 736 7589 ♦ FAX +1 386 734 7537  
 uPT@uPTVECTOR.COM ♦ WWW.UPTVECTOR.COM

**54" Drogues**

Apply about 10 lbs. of tension against the Kevlar bridle and with the other hand apply the same tension on the kill line by pulling on the kill line attachment bridle or the drogue handle. The larks head knot at the bottom of the kill line attachment bridle should be 1½" (39mm) above the kill line guide grommet on New Drogues (factory setting).

As drogues become more used, this setting may require lengthening to shorten the trap door affect.

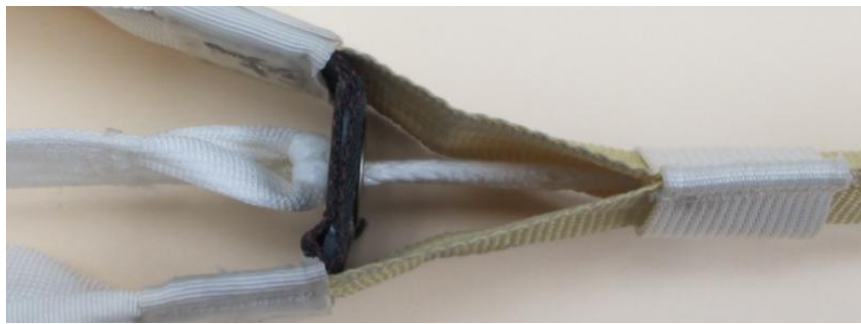

If this distance is more than 1" (26mm) less, the larks head knot will impact the guide grommet at high speed, quickly causing damage to both. However, in this instance, deployment, while slightly slower, will still happen more or less normally.

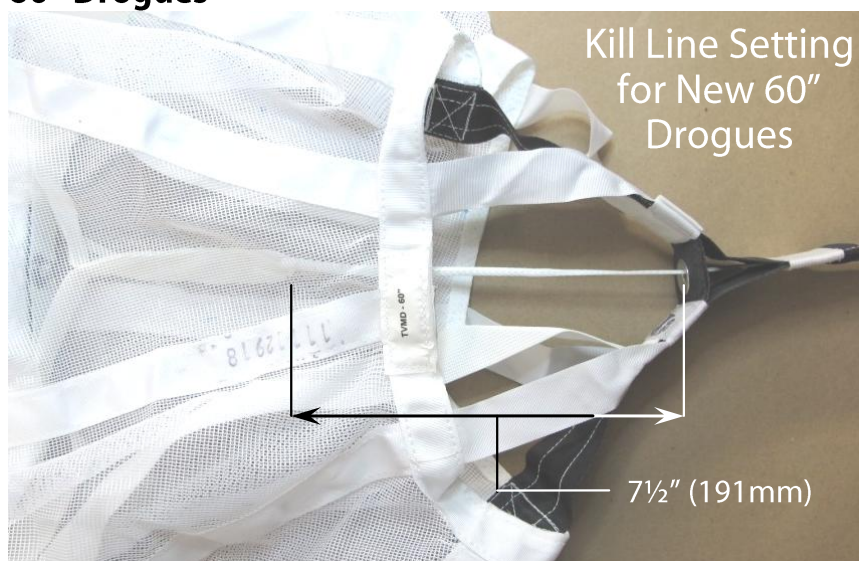
**60" Drogues**

Using the same technique as above applying about 10 lbs. of tension, the larks head knot at the bottom of the kill line attachment bridle should be 7½" (191mm) above the kill line guide grommet on New Drogues (factory setting).

As drogues become more used, this setting may require lengthening to shorten the trap door affect.

## Lengthening the Drogue Kill Line

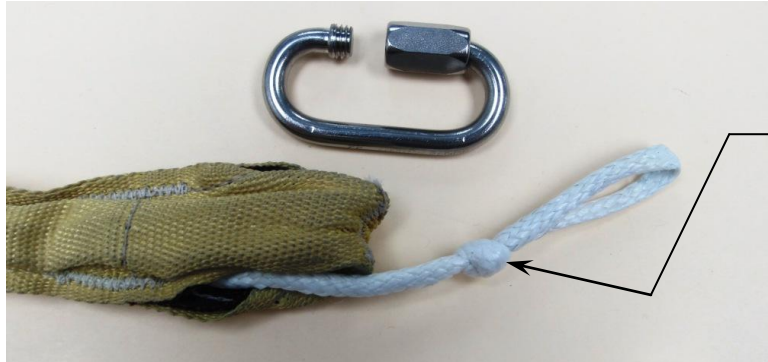

Drogue collapse is calibrated for average weight and fall rates, if you feel the drogue is collapsing too far with longer than normal "trap door" you may lengthen it a little bit by untying the knot and letting out required length of finger trap. Ideal trap door time is  $\frac{3}{4}$  sec. with a minimum of  $\frac{1}{2}$  sec.



You may also attach a Slink using a lark's head knot as shown to the left to lengthen and reduce the amount of collapse.



The link is then attached to the Slink, bridle and bag.

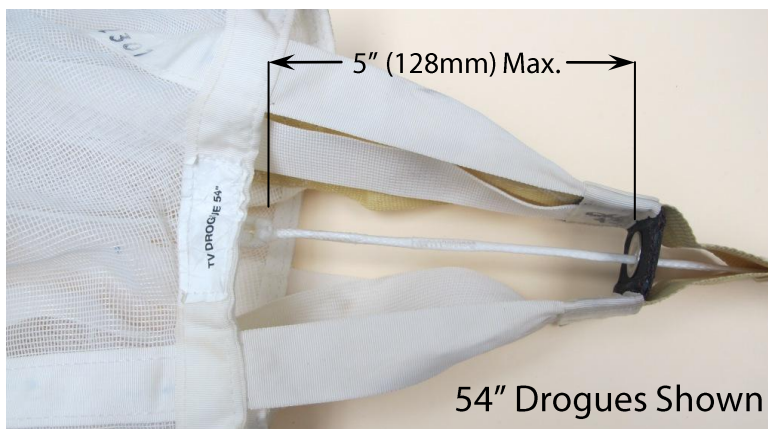

5" (128mm) is the maximum length the kill line may be let out to.

54" Drogues Shown



## Shortening the Drogue Kill Line

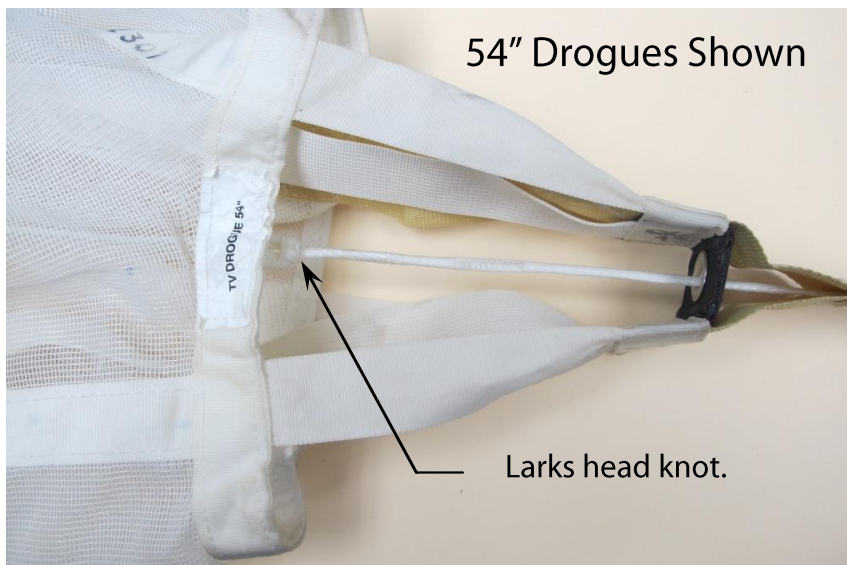

If this distance is more than 2" (51mm) greater, the drogue may not fully collapse, yielding a higher snatch force, increased chance of malfunction due to line dump, and increased chance of canopy damage.



**If you notice a kill line that is too long**, a simple overhand knot, tied within the finger-locked section of the kill line, at the deployment bag end, will effectively shorten it almost 2" (51mm), and bring your drogue collapse system back into trim.

# REVISION LOG

## SIGMA TANDEM MANUAL

REV #	CHANGES	DATE
0.1	Malfunction procedure diagram corrected. Sec.4 Ch.1	7/20/2016
0.2	Edits to standardize verbiage. Sec.2 Ch.2	9/6/2016
0.2	Malfunction procedure diagram updated. Sec.4 Ch.1	9/6/2016
0.3	Student Harness Attachment verbiage clarified. Sec.2 Ch.2	3/7/16
0.3	Addition of M2 to list of Approved AADs. Sec.2 Ch.2	3/7/16
0.4	Added AAD Installation Update. Sec.2 Ch.3	5/17/17
0.4	Added Main Deployment Bag Attachment Update. Sec.2 Ch.3	5/17/17
0.4	Added Main Brake Stowing Update. Sec.2 Ch.3	5/17/17
0.4	Added Main Closing Sequence Update. Sec.2. Ch.3	5/17/17
0.4	Updated Emergency Procedure Flow Charts Sec.4 Ch.1	5/17/17
0.4	Updated Emergency Procedure Descriptions. Sec.4 Ch.1	5/17/17
0.4	Added Drogue Calibration Documentation. Sec.4 Ch.1	5/17/17
0.5	Reorganized Currency Requirements. Sec.1 Ch.2	9/5/19
0.5	Added Vigil 2+ & Cuatro to Approve AAD list. Sec.1 Ch.3	9/5/19
0.5	Added explanation of centerline attachment. Sec.2 Ch.4	9/5/19
0.5	Added Instructions for New Main Bag Sec.2 Ch.4	9/5/19
0.5	Added explanation of drogue screw. Sec.2 Ch.4	9/5/19
0.5	Added drogue setting outcome. Sec.2 Ch.4	9/5/19
0.5	Added drogue calibration criteria. Sec.2 Ch.4	9/5/19
0.5	Added main pin criteria. Sec.2 Ch.4	9/5/19
0.5	Added drogue fold criteria. Sec.2 Ch.4	9/5/19
0.5	Added Student Briefing Criteria. Sec.2 Ch.4	9/5/19
0.5	Added Landing criteria. Sec.3 Ch.1	9/5/19
0.5	Added student hand position criteria. Sec.3 Ch.1	9/5/19
0.5	Added exit criteria. Sec.5 Ch.1	9/5/19
0.5	Added altimeter check. Sec.5 Ch.1	9/5/19
0.5	Added deployment criteria. Sec.5 Ch.1	9/5/19

SIGMA TANDEM MANUAL

0.5	Added 90 degree turn criteria. Sec.3 Ch.1	9/5/19
0.5	Added Emergency Procedure Criteria. Sec.4 Ch.1	9/5/19
0.5	Added Left side procedure for camera EP. Sec.3 Ch.2	9/5/19
1.0	Added equipment limitations per TSO C23F Sec.1 Ch.1	4/2/2021
1.0	Added Sigma Tandem Donning Instructions Sec.2 Ch.2	4/2/2021
1.0	Added Sigma II Reserve Assembly Instructions Pg. 25-31	4/2/2021
1.0	Added Setting The Sigma II Reserve Brakes Pg. 36-38	4/2/2021
1.0	Added Packing The Sigma II Sec.2 Ch.3	4/2/2021
1.0	Added VR 360 Reserve Deployment Bag compatibility Sec.2 Ch.3	4/2/2021
1.0	Added SR/340 & SR370 Reserve Deployment Bag Compatibility Sec.2 Ch.3	4/2/2021
1.1	Fixed Various Typos	5/21/2021
2	Altitude discrepancy changes, updates and clarifications of doctrine for training purposes	2/1/2024