

HR-360-R2

HEAVY RESERVE PARACHUTE

BY PERFORMANCE DESIGNS, INC.



1300 E. International Speedway Blvd. DeLand, FL 32724
TEL: 386.738.2224 www.performancedesigns.com FAX: 386.734.8297

TMAN-002 - FFB 2005 - RFV 0

CONTENTS

SECTION 1: INTRODUCTION

CONTENTS.....	02
WARRANTY AND DISCLAIMER.....	06
CANOPY PACKING/DEPLOYMENT LOG.....	07

SECTION 2: PERFORMANCE SPECIFICATIONS

TEST REQUIREMENTS.....	10
BREAKAWAY TEST DATA.....	11
STRENGTH TEST DATA.....	17

SECTION 3: PARACHUTE MAINTENANCE AND REPAIR

RESERVE PARACHUTE INSPECTION.....	22
ATTACHING THE RESERVE TO THE RISERS.....	26
ATTACHING DACRON STEERING LINES TO TOGGLES.....	28
CLEANING THE PARACHUTE ASSEMBLY.....	36
REPAIR LIMITATIONS.....	40
BASIC PATCH.....	42
LINE REPLACEMENT.....	50



SECTION 4: PACKING INFORMATION

REPACK CYCLE.....54
PACKING INSTRUCTIONS FOR HR-360-R2.....56

SECTION 5: DRAWINGS

TOP DRAWING PACKAGE.....74
DAMAGE CHART.....78



(PAGE INTENTIONALLY LEFT BLANK)

SECTION 1:
INTRODUCTION

WARNING AND DISCLAIMER

It is beyond the scope of this manual to teach you how to deploy, fly, land, or maintain this parachute. This manual is only a general guide about this parachute. It is not a replacement for proper training and instruction.

Parachute systems sometimes fail to open properly, even when properly assembled, packed, and operated. There is a risk of equipment damage, serious injury, or death each time this system is used.

Each time you use this parachute you risk bodily injury and death.

You can substantially reduce this risk by: **(1)** assuring every component of the parachute system has been assembled and packed in strict accordance with the manufacturer's instructions. **(2)** by obtaining proper instruction in the use of this canopy and the rest of the equipment, and **(3)** by operating each component of the system in strict compliance with the owner's manual and safe parachuting practices.

STATEMENT OF COMPLIANCE

The policies contained herein comply with the Federal Aviation Regulations, Part 21.

REVISION LIST

Performance Designs, Inc (PD) may revise this manual at any time. The only way to be sure this manual is current for your canopy is to check periodically with PD or check www.performancedesigns.com. PD welcomes suggestions of ways to improve this publication. If you feel parts are incomplete or hard to understand, please let us know by writing or emailing PD. Copyright 2005, Performance Designs, Inc.

DISCLAIMER NO WARRANTY

Because of the unavoidable danger associated with the use of this parachute, the manufacturer makes no warranty, either expressed or implied. It is sold with all faults and without any warranty of fitness for any purpose. The manufacturer also disclaims any liability in tort for damages, direct or consequential, including personal injuries resulting from a defect in design, material, workmanship or manufacturing whether caused by negligence on the part of the manufacturer or otherwise.

By using this parachute assembly, or allowing it to be used by others, the user waives any liability of the manufacturer for personal injuries or other damages arising from such use.

CANOPY PACKING/DEPLOYMENT LOG

As any conventional ram air reserve is repeatedly handled and repacked, the fabric permeability will increase. This increased permeability will affect opening, flight and/or landing characteristics. To monitor this important issue, we have incorporated a tracking and inspection program into our reserve canopies. Compliance with this program is mandatory. Each time the reserve is inspected and packed, a single diagonal line \ is to be placed in the next open box on the label. In the event of an actual deployment, an X is to be placed in the next available box.

The warning label should accurately reflect the repacks and uses on that reserve canopy. In the event a rigger encounters a discrepancy between the packing data card and the warning label, the label should be brought into compliance, just as the rigger would do with any other piece of equipment. The owner of the reserve



should be informed that the rigger is simply complying with Performance Designs' requirement for the label to accurately reflect the repacks and/or uses on that canopy.

After 40 repacks or 25 deployments have been reached, the reserve must have its permeability tested. (In most countries, 40 repacks are usually performed over a 10 to 20 year period.) The testing is performed to insure that the fabric permeability has not reached a point where the openings and landing performance would be unacceptable. Subsequent to passing this testing, an additional label is affixed and the canopy is then returned into service. The label will contain additional boxes, the specific number being chosen according to the results of the test.



(PAGE INTENTIONALLY LEFT BLANK)

SECTION 2:
PERFORMANCE SPECIFICATIONS

INTRODUCTION

The Performance Designs, Inc. reserve parachute HR-360 R2 is currently being evaluated as per testing requirements contained in TSO C23d. Performance specifications for the HR-360 R2 military reserve parachute are recorded and summarized in this document. The data includes breakaway information such as associated altitude loss from the breakaway and opening data for the HR-360 R2.

This document contains the test results, the qualifying test data obtained, and associated graphs for the additional tests. While reviewing the test results, adequate safety margins must be added to these figures to derive operational limitations.

All test results are from jumps that have been made with new equipment. Experienced test jumpers perform all test jumps. Results may vary with different jumpers, equipment condition, packing, and various component combinations.

TSO tests are oriented towards normal skydiving use near sea level. For some parameters such as opening times and distance, no allowances are given for the increases in true airspeed with increasing altitude. Parachutes that are designed to open fast enough to meet the TSO requirements near sea level may open far too fast at high altitudes, causing opening shocks high enough to be fatal or to cause equipment failure. For this reason, parachutes designed to open at high altitudes are generally designed to be slower opening canopies and may not meet the opening speed/distance requirements of the TSO.

SUMMARY OF TSO TEST REQUIREMENTS

Heat Test (4.3.3.1) - heated for 16 hours at $\geq 200^{\circ}\text{F}$ (93.3°C), stabilized to ambient temperature, then test dropped.

Cold Soak Test (4.3.3.2): cooled for 16 hours at $\leq -40^{\circ}\text{F}$ (-40°C), stabilized to ambient temperature, then test dropped.

Compression Test (4.3.3.3): compressed with ≥ 200 lbf (889.6N) load for ≥ 400 continuous hours, then test dropped within one hour after load removal.

Strength Test (4.3.4): test weight is maximum operating weight limit x 1.2 and the test speed is maximum operating speed limit x 1.2. This test consists of 3 consecutive drops performed at or near sea level. There shall be no evidence of damage that will affect airworthiness to pass the test.

Twisted Lines Test (4.3.5): three, 360° twists purposely packed in the suspension lines adjacent to the risers. Minimum of 5 drops required. Parachute must open within time calculated in section 4.3.6 (+1 second).

Direct Drop Test (4.3.6.1): 6 drops at maximum weight. 48 drops at \leq maximum weight. Parachute must open within time calculated in section 4.3.6.

Breakaway Drop Test (4.3.6.2): 8 drops by a person at \leq maximum weight from a parachute in full flight (not more than 20 fps). Parachutes for certification with 550 lbs must be open within 600 feet.

Rate Of Descent Test (4.3.7): 6 drops \geq maximum weight. Average rate of descent shall not exceed 24 ft/s (7.3 m/s).



Stability Test (4.3.8): 6 drops at _ the maximum weight. Oscillations shall not exceed 15° from vertical.

Live Drop Tests (4.3.9): minimum 4 drops ≤ maximum weight. (2 drops with freefall ≤ 3 seconds and 2 drops with freefall ≥ 20 seconds). User must suffer no significant discomfort from opening shock. User must be able to disengage himself unaided from harness after landing.

BREAKAWAY DATA SUMMARY

The following table compiles the data obtained from the five breakaways. All test results were satisfactory. The average altitude it took for the reserve parachute to open was 843.1 feet (257.0 meters). The average amount of time it took for full reserve parachute deployment was 17.06 seconds. Performance Designs declares the reserve parachute fully open at the point where the vertical velocity (descent rate) is equal to 15 fps with suspended weight of approximately 220 lbs. The declaration is more conservative than the descent rate required for TSO acceptance – which means that there is a larger margin of safety built into the Performance Designs calculations.

DROP #	START OF BREAKAWAY ALTITUDE	ALTITUDE RESERVE FULLY OPEN	TOTAL ALTITUDE LOSS FROM BREAKAWAY TO FULL OPEN RESERVE	TOTAL TIME FROM BREAKAWAY TO FULL OPEN RESERVE
1	2274 feet	1399.25 feet	874.75 feet	17.47 sec
2	3898 feet	3046.14 feet	851.86 feet	17.72 sec
3	3948 feet	3228.55 feet	719.45 feet	13.70 sec
4	3717 feet	2846.50 feet	870.50 feet	17.57 sec
5	3851 feet	2952.22 feet	898.78 feet	18.83 sec

BREAKAWAY TEST DATA

Five breakaway tests were performed for the HR-360 R2 and data points graphed. The graphs display time versus altitude (feet) for the entire parachute flight including breakaway sequence. Two graphs are included for each test drop. The first of each set of graphs includes the entire flight from deployment to breakaway sequence to reserve parachute deployment and flight. The second graph of each set is the exploded view of the breakaway section only.

The design focus for the HR-360 R2 reserve is safe, smooth openings at high altitudes. The HR-360 was not designed to cutaway at extremely low altitudes.



BREAKAWAY TEST DROP 1



(Top) Graph of parachute flight (includes main flight, breakaway, and reserve flight). The box highlights the breakaway portion.

Exploded view shown below.

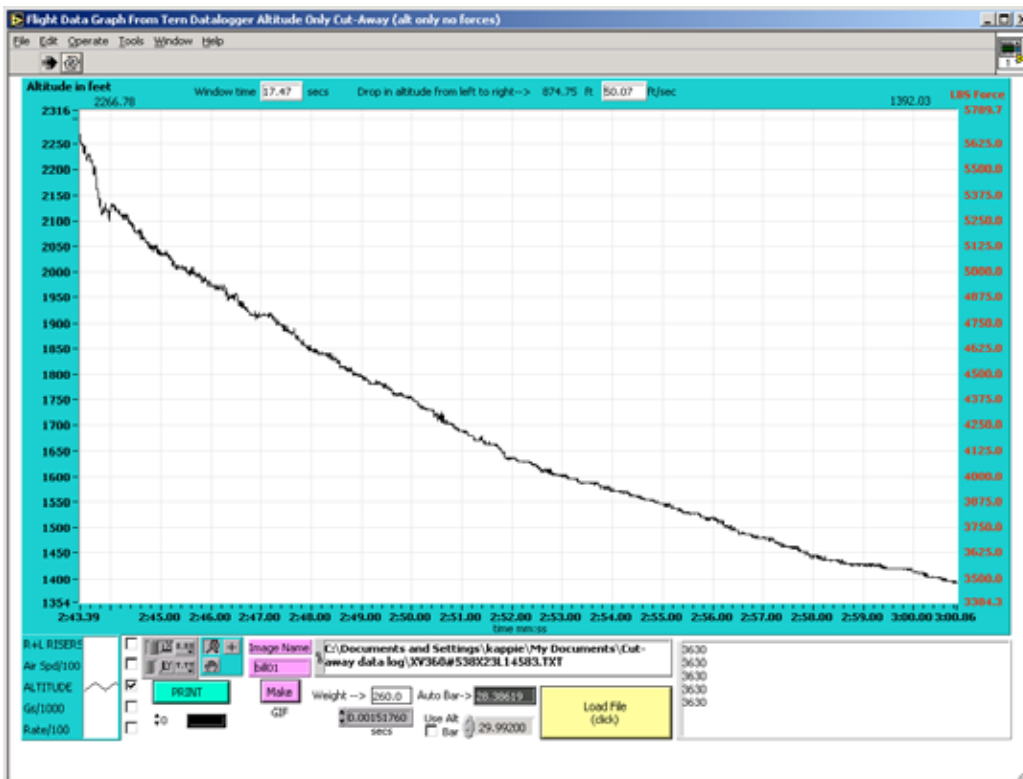

BREAKAWAY TEST DROP 2



(Top) Graph of parachute flight (includes main flight, breakaway, and reserve flight). The box highlights the breakaway portion.

Exploded view shown below.

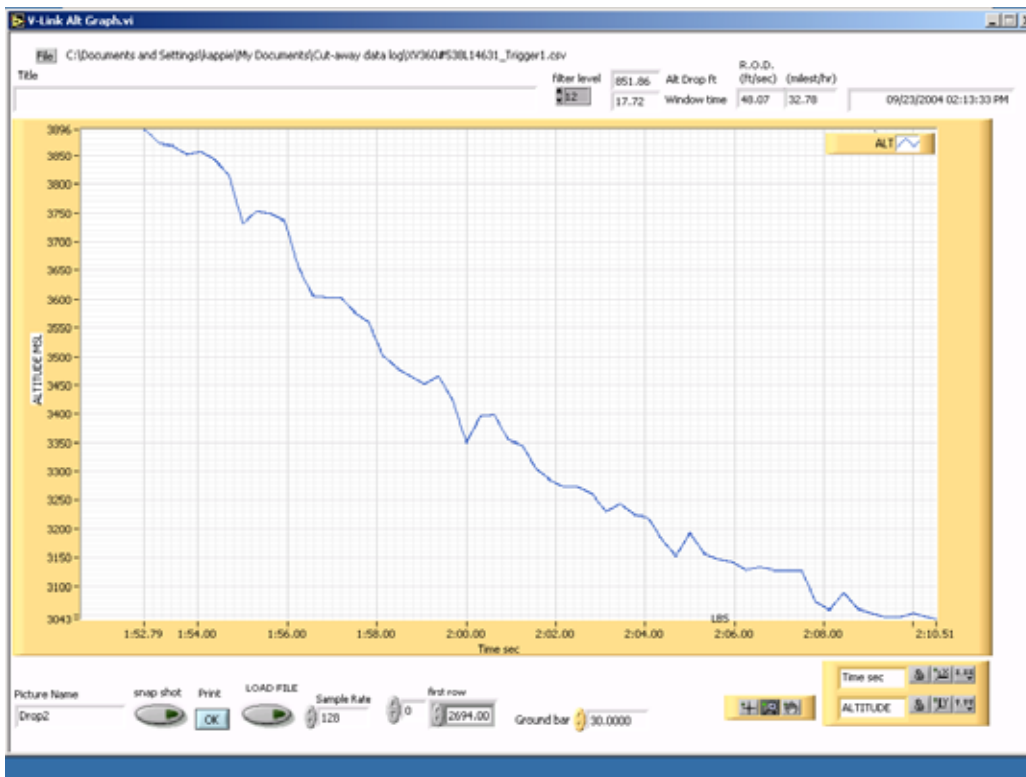

BREAKAWAY TEST DROP 3



(Top) Graph of parachute flight (includes main flight, breakaway, and reserve flight). The box highlights the breakaway portion.

Exploded view shown below.

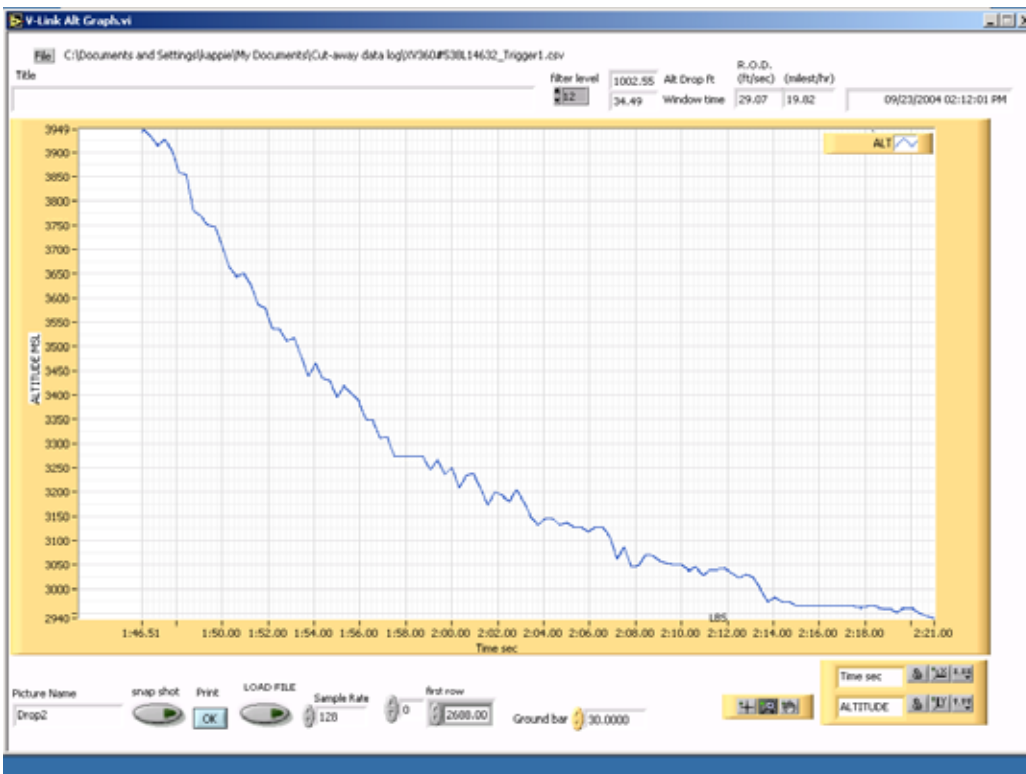

BREAKAWAY TEST DROP 4



(Top) Graph of parachute flight (includes main flight, breakaway, and reserve flight). The box highlights the breakaway portion.

Exploded view shown below.

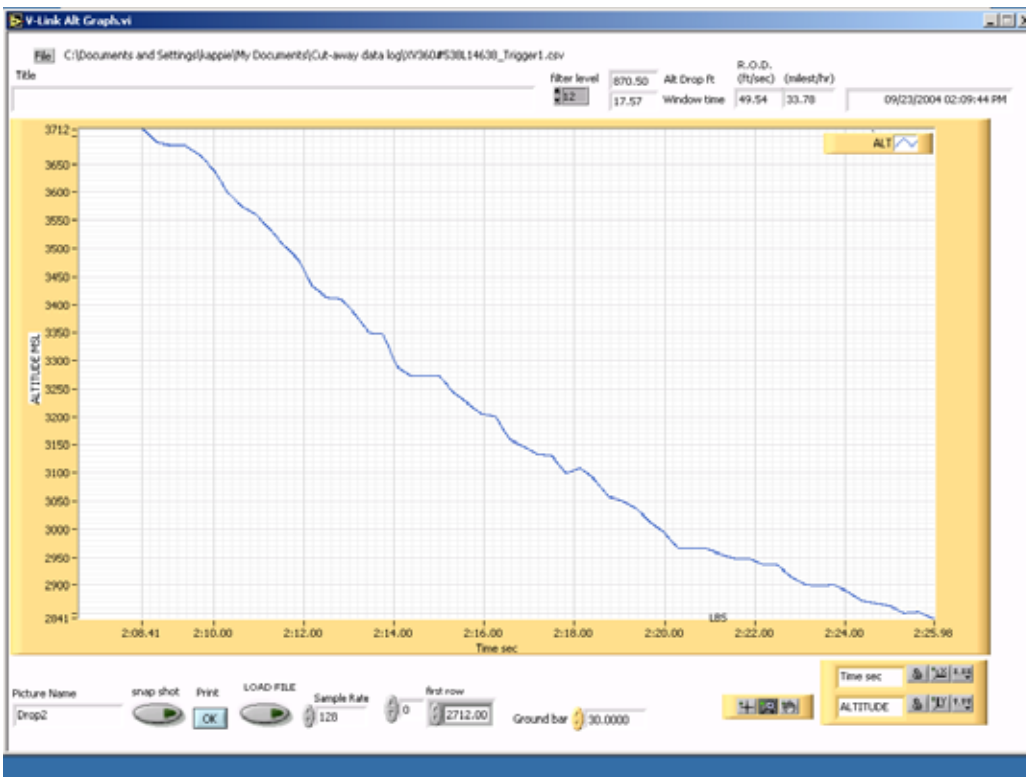

BREAKAWAY TEST DROP 5



(Top) Graph of parachute flight (includes main flight, breakaway, and reserve flight). The box highlights the breakaway portion.

Exploded view shown below.

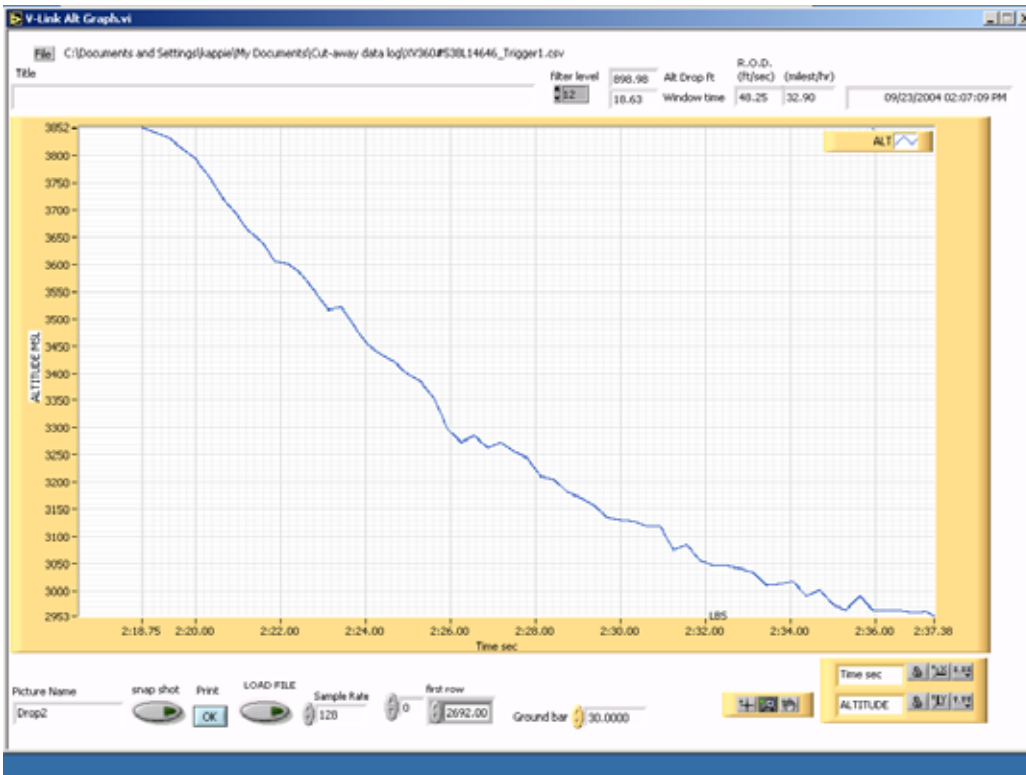

STRENGTH TEST DATA SUMMARY

The following table compiles the data obtained from the three heavy load deployments. All test results were satisfactory.

DROP #	PAYLOAD WEIGHT	SPEED	MAX RECORDED LOAD	CALCULATED PEAK G-FORCE
1	660 lbs	228 kts	11139.3 lbs	16.88
2	660 lbs	228 kts	5796.2 lbs	8.78
3	660 lbs	228 kts	6577.6 lbs	9.97

STRENGTH TEST DATA (HEAVY DROP DATA)

Three heavy drop tests were performed with the HR-360 R2 and associated data points were recorded. The graphs display time versus load. Two graphs are included for each test drop. The first of each set of graphs includes approximately 15 seconds of flight including opening. The second graph of each set is the exploded view of the opening.

STRENGTH TEST DROP 1

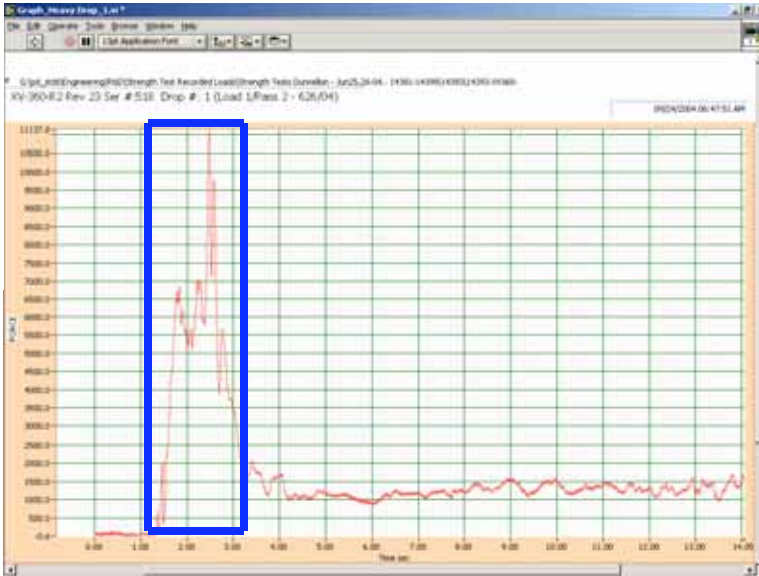

(Top) Graph of parachute deployment including approximately 10 secs of flight. The box highlights the parachute deployment. Exploded view shown below.



STRENGTH TEST DROP 2



(Top) Graph of the parachute deployment including approximately 10 secs of flight. The box highlights the parachute deployment.

Exploded view shown below.



STRENGTH TEST DROP 3

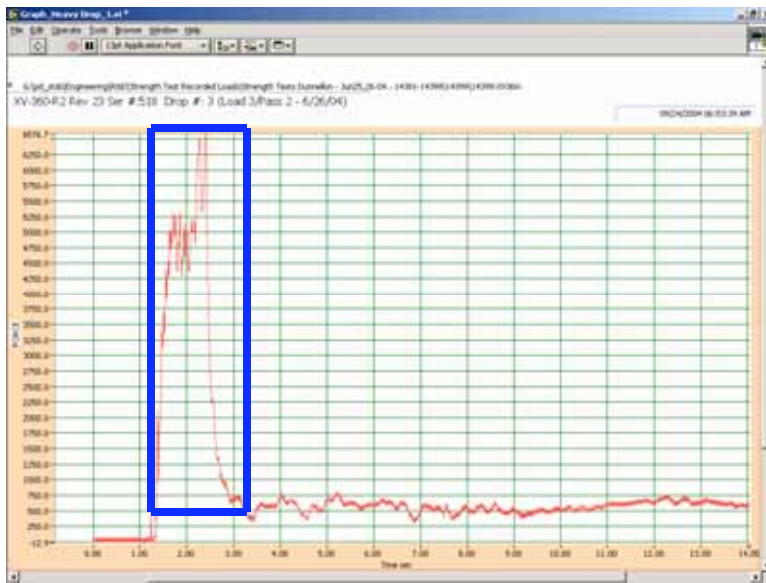

(Top) Graph of parachute deployment including approximately 10 secs of flight. The box highlights the parachute deployment.

Exploded view shown below.



SECTION 3:
PARACHUTE MAINTENANCE AND REPAIR

RESERVE PARACHUTE INSPECTION

OVERVIEW

The Performance Designs reserve parachute must be inspected thoroughly before its first pack and before each subsequent repack. This inspection should be performed with even more care and attention when first assembled and after a deployment. A certificated rigger must inspect the new Performance Designs reserve and determine its compatibility with your rig. This inspection should be done in a clean, well-lit area with enough room to spread out the reserve parachute.

The following is the Performance Designs recommendation for reserve parachute inspection. Consult the owner's manual for the harness and container and other components for instructions for inspection.

VISUAL INSPECTION

TOP SURFACE

Spread the parachute out on its bottom surface and inspect the top surface starting at the front of the left end cell. Check half of the cell from nose to tail. Then check the other half from tail to nose. Repeat this pattern until each cell's top surface has been inspected. Look for rips, stains, snags, burns, abrasions or failed seams.

BOTTOM SURFACE

Turn the parachute over and spread it out to inspect the bottom surface. Again use the procedure of inspecting half-cells as on the top surface. Check for rips, stains and failed seams. Look very closely at the line attachments. Even slight damage is cause for rejection in these areas. Line attachments must be completely free of any damage or defects. Check under the ends of the line tabs.

RIBS

Inspect each rib from leading edge to the trailing edge by looking inside each cell. Pay extra attention to the line attachment points. Check for items such as burns, tears, seam integrity and pulled threads. Also check the cross ports.

STABILIZERS AND LINE CONNECTIONS

Lay the parachute neatly on one side, stacking each loaded rib on top of the others. Check that all lines in each line group are the same length and that the trim differential between each line group is correct for this reserve. Check the condition of the stabilizers and slider stops on the stabilizer.

SUSPENSION LINES

Check the full length of each line for damage and wear. Look for fraying at all cascades and where each line attaches to the connector link. Check that all lines are sewn and that the stitching is good. Check the continuity and routing of each line.

SLIDER

Ensure the fabric is not torn, the grommets are undamaged with no sharp edges, and that they are securely attached to the slider. Be sure every suspension line and both steering lines pass through the proper grommet on the slider. Inspect the integrity of the bridle attachment points on the slider.



RISER AREA

Visually check the link and its condition. If the link is not bent, cracked or damaged, the link is ok for continued service.

PROTECTIVE LINK COVERS

Insure that the protective link covers located on the connector links are the correct ones, are positioned correctly, are in good condition and are properly secured with tacking cord.

TOGGLES

The toggles must be installed correctly and must match the guide ring and the hook and loop fastener on the risers. Performance Designs canopies come with brake settings and toggle tie on marks set for PIA standard riser/brake dimensions. This standard calls for 4 inches (10.2 cm) from the top of the riser to the top of the brake-setting ring. If the risers are more than 1 inch or (2.5 cm) different from this standard the parachute must be modified. This modification may only be done by a master rigger and must be reported to Performance Designs, Inc. In addition, any changes must be marked on the parachute's data panel.

FABRIC TESTING

STRENGTH

Performance Designs recommends that a random sample of 10% of all reserves placed in service within your organization be strength tested once per year. A minimum of 3 per year should be tested if the inventory is less than 30 parachutes. If a failure occurs during one of the tests, the cause of that failure shall be determined. If the cause of fabric failure is due to an isolated event (i.e. acid contamination or a cigarette burn), then the testing may be continued at the 10% level. If the cause of the failure is undetermined, contact the manufacturer for further guidance on further testing and any other required actions. The environment in which the parachute has been used may have a significant effect on the strength of the fabric (i.e., desert sun, salty conditions).

Use commercially available 1-inch (2.5 cm) wide fabric testing clamps with rubber-faced jaws and appropriate scale. The scale should be calibrated at least once per year and be accurate within 1.0 lb (0.45 kg). The clamps should be free of any burrs or rough edges that could snag the fabric.

Three fabric strength tests should be performed on each of the following locations on the parachute:

- left end cell, top surface
- right end cell, top surface
- center top surface near trailing edge

The test should never be done where any part of the fabric involved in the test is within 3 inches (7.6 cm) of any seam or the data panel. The test should be done chord-wise. An additional test must be performed on any stained or discolored areas.

Attach the locking fabric clamps to the ripstop fabric. The distance between the clamps should be 3 inches (7.6 cm) and the clamps should be aligned so that the ripstop pattern is parallel to the edge of the jaw.

Lock the clamps securely to avoid slippage. Pass a short length of cord through the eye of one clamp and secure to the packing table or other object that will allow a 30 lbs (13.6 kg) load without movement.



Pass the hook from the spring scale through the other eye and apply a 30 lbs (13.6 Kg) load for 3 seconds.

PERMEABILITY

The permeability of the fabric is very important. As the permeability increases, the parachute will open more slowly and flight performance will deteriorate. The rate of descent will increase and the forward speed will decrease. The ability of the parachute to flare to a soft landing will decrease.

To ensure the parachute is safe to use, Performance Designs has established an average permeability limit of 8.0 cfm for the reserve parachute throughout its service life.

Fabric permeability does not change while the parachute is packed; it changes because of use, packing and handling. That's why it is important to maintain a complete history of the parachute.

Fabric permeability must be tested if any of the following events occur:

- The parachute is completely submerged in water.
- 25 jumps have been made on the parachute since it was new or last certified.
- The parachute has been repacked 40 times since it was new.
- The parachute has an unknown number of jumps, repacks, or there is reason to believe that jumps or repacks were not properly logged.
- Flight performance appears to be substandard.
- There are other reasons to believe the fabric permeability may exceed specifications.

The Performance Designs factory is equipped to perform permeability testing. It is recommended that any parachute needing such testing be returned to the factory.

MAINTENANCE AND REPAIRS

Information on maintenance, repairs and associated limitations may be found in the chapter entitled "Repair Limitations."

ATTACHING THE RESERVE TO THE RISERS

ATTACHING THE RESERVE TO THE RISERS

OVERVIEW

When assembling a Performance Designs canopy onto risers it is important that the directions are followed precisely. The first time you perform an installation, it should be under supervision. If these directions are followed correctly, and only parts supplied by Performance Designs are used, these links will provide excellent service.

CONNECTOR LINKS

Remove all grease and dirt from links, using a solvent that will leave no residue. Trichloroethylene or electrical contact cleaner is recommended.

Inspect the links carefully. Check for nicks, burrs and any sign of bending or stress. Check to be sure the barrel will screw down at least 2-3/4 turns from first engagement with no resistance.

If the bumpers are not already installed, slide them over the links and onto the lines. You can use a pull up cord to assist you in doing this.

Attach the connector links onto the risers and tighten the links - finger tight.

Perform a thorough line continuity check at this point, making sure that the canopy is rigged correctly.

Tighten the link finger tight and torque to 20-30 in lbs-force (2.26 – 3.39 Nm). To accurately gauge this, place a 5 lb. (2.27 kg) weight on a wrench, 5 inches (12.7 cm) from the link. When the wrench is horizontal and the barrel no longer turns, the link is fully tightened. Do not tighten more than 30 in lbs-force (3.39 Nm).

ATTACHING DACRON STEERING LINES TO TOGGLES

ATTACHING DACRON STEERING LINES TO TOGGLES

OVERVIEW

The following contains instructions on toggle attachment. A mark is provided on the parachute steering line that is the best location for the toggle. If the toggles are above the mark, the parachute will not have the forward speed it should and may not land well.

Attach the steering toggles according to the rig manufacturer's instructions if they are compatible with the type of steering line used. Be sure the knot cannot get caught on the riser guide ring.

If the rig manufacturer gives no conflicting instructions, then Performance Designs recommends either of the following methods. The methods shown will work well for most toggles.

PROCEDURE

NOTE: Prior to hooking up the steering toggles, make sure the steering line passes through the grommet on the slider.

Route the steering line through the guide ring located on the riser.

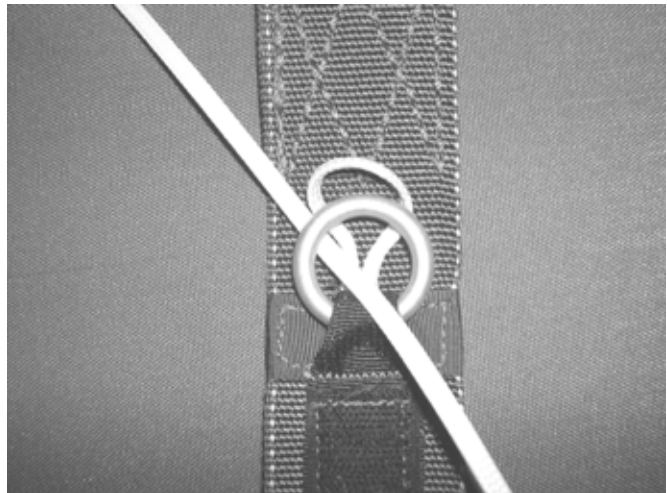

Continue to route it through the grommet in the toggle, starting from the hook and loop fastener side.

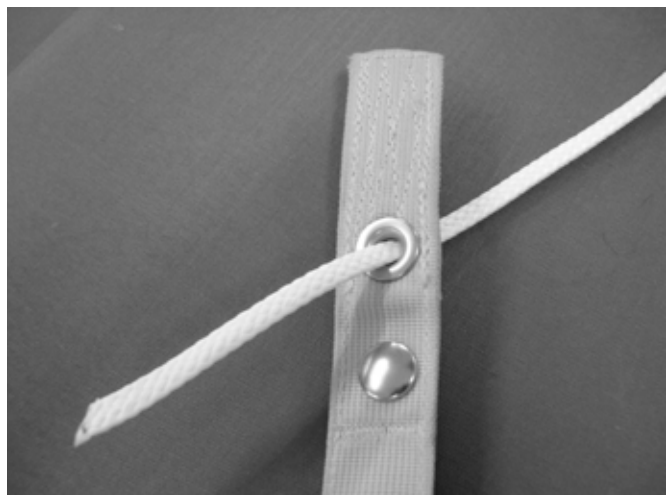

While holding the toggle mark in place, wrap the cut side of the steering line around the toggle 1 _ times.

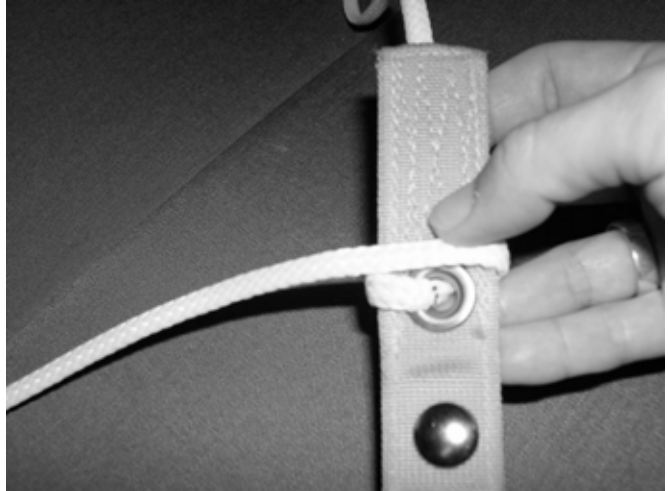

Insert the steering line thru the grommet again from the backside of the toggle.

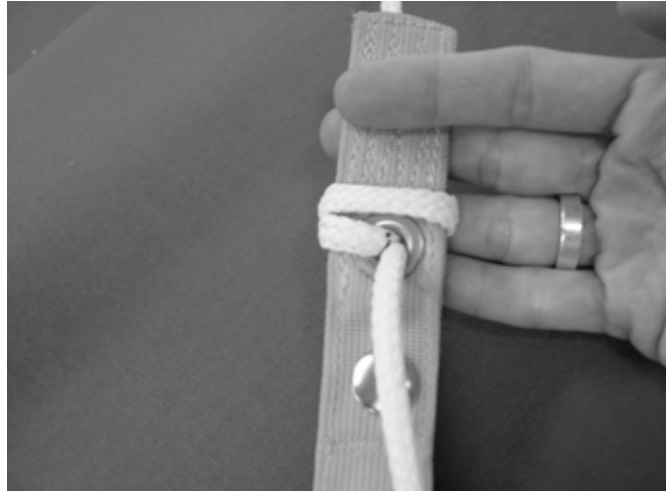

Tie a half-knot in the steering line...

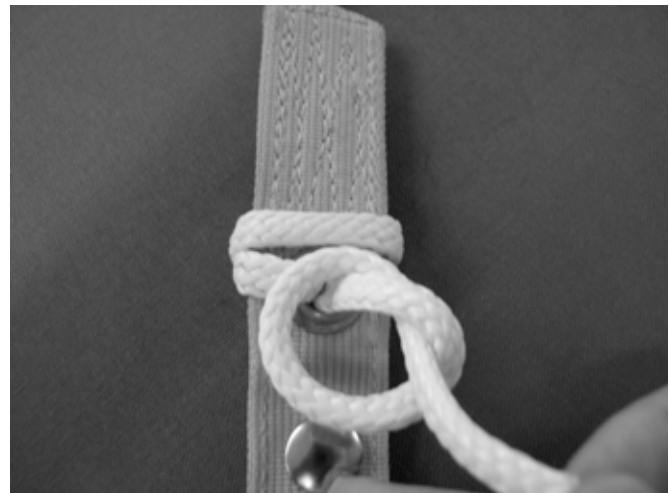

Cinch it against the toggle.

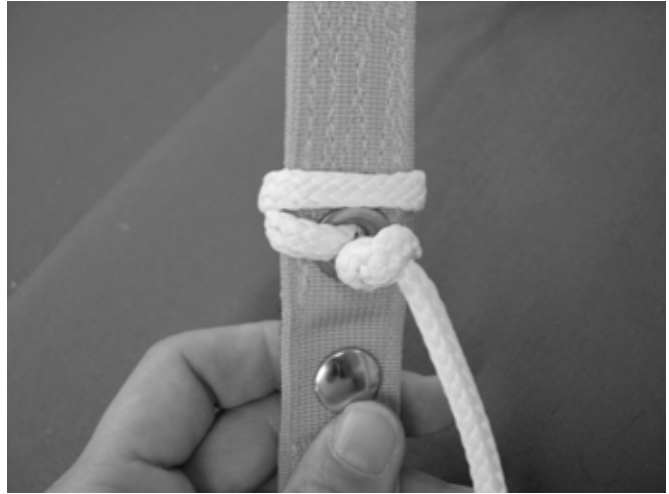

Tie another half-knot wrapping the line between the existing knot and the grommet.



Cinch it down tightly against the toggle.

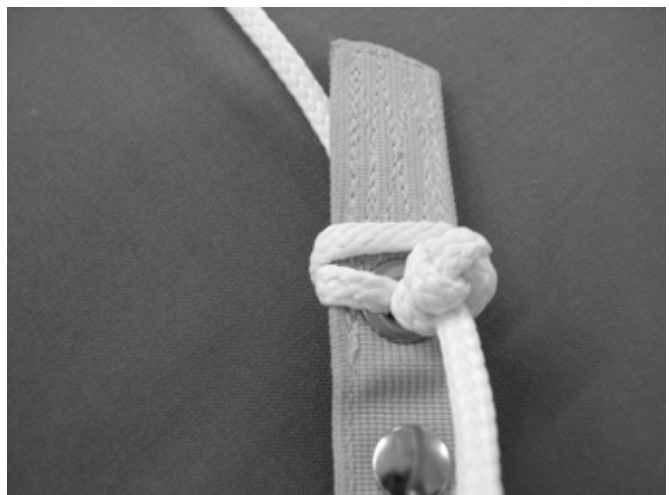

ALTERNATE METHOD

The factory toggle mark is located 23 inches from the top of the cat-eye.

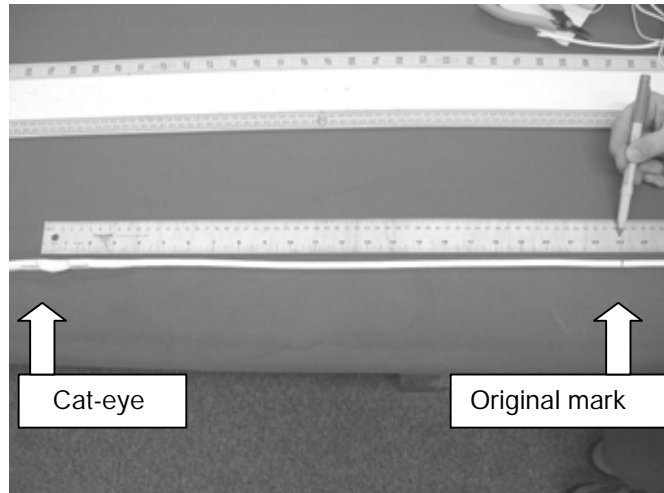

Working towards the cut tail, place a mark at each of the following locations:

- $\frac{1}{2}$ " from the original mark towards the tail
- 3 $\frac{1}{2}$ " from the original mark towards the tail
- 6 $\frac{1}{2}$ " from the original mark towards the tail. This is the cut mark.

Use different color ink than the factory placed mark to help distinguish between the original and the newly placed marks.

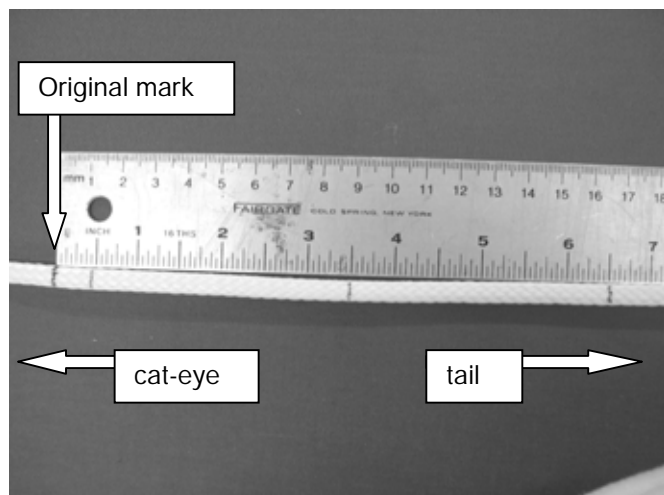

At the 6 $\frac{1}{2}$ " mark, cut the line at an angle using scissors. Do not use a hot knife.

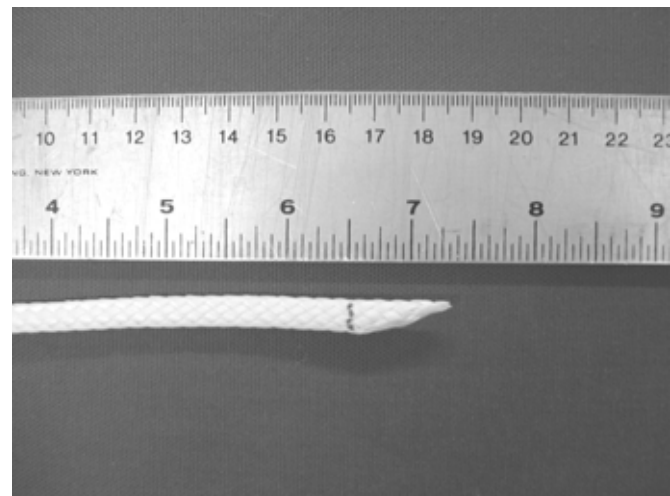

Insert the finger-trapping tool into the line at a distance greater than the amount of line being finger-trapped. The finger trap tool shall emerge at the 6" mark drawn in step 2.

The line between the 3" mark and the 6" mark is the portion to be finger-trapped.

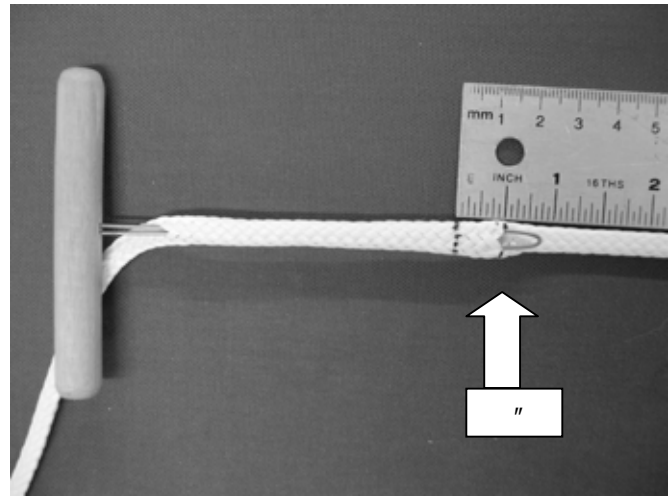

Insert the tail of the line thru the eyelet of the finger-trapping tool.

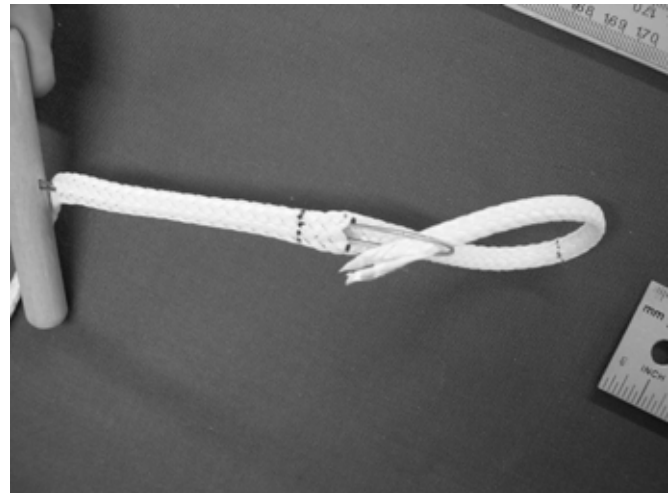

Pull the line thru until the 3" mark and the 6" mark are in alignment.



Remove the fingertrap tool. Ensure the tail remains completely inside the line.

Place a bartack (or its equivalent) at the fingertrap insertion point to secure the fingertrap.

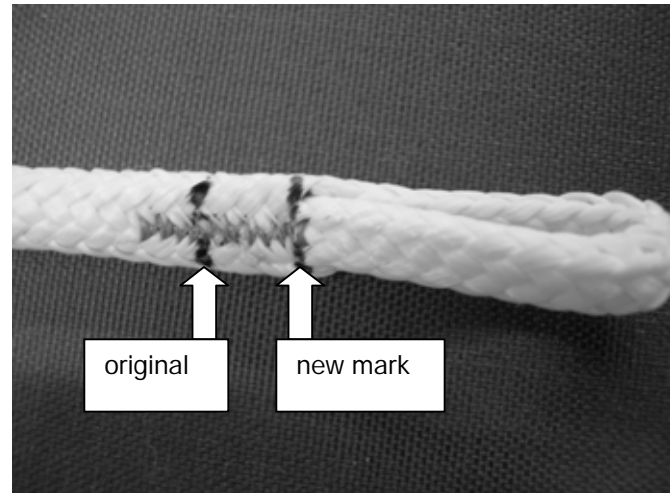

Double-check your measurements against the tape. The distance between the top of the cat-eye...

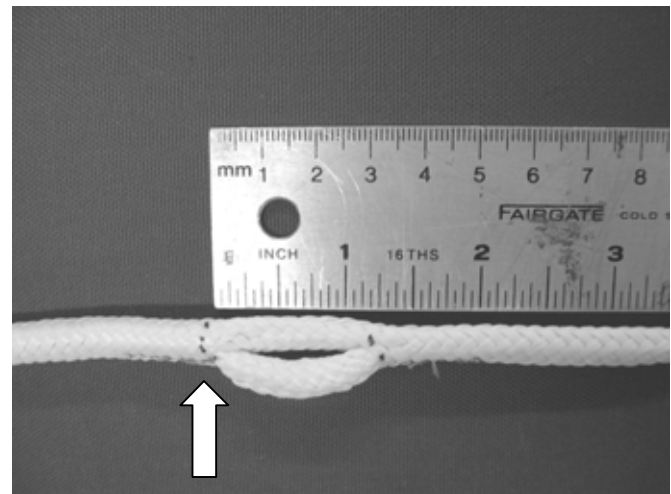

...and the start of the finished loop should be 23 inches.

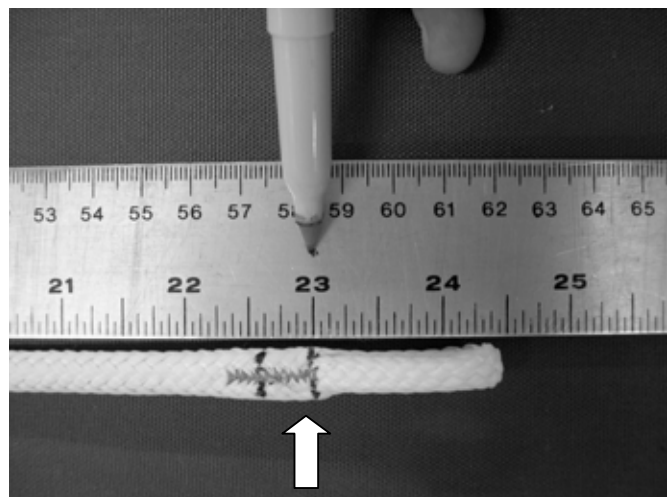

Push the finished loop through the back of the toggle.

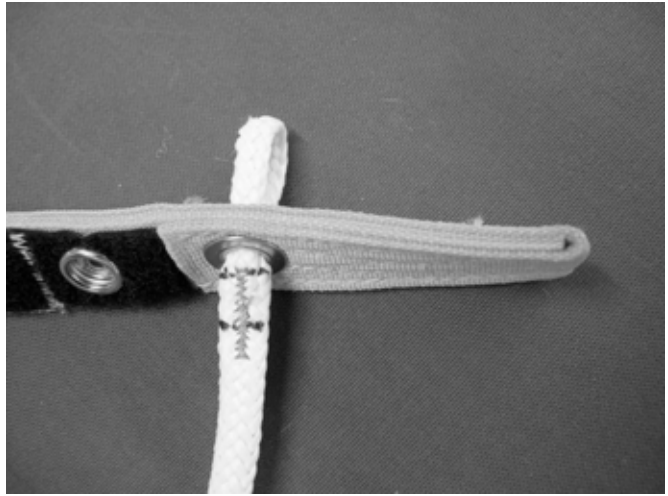

Thread the toggle through the finished loop creating a lark's head knot. Do not thread the upper end of the toggle through the loop because this is not a secure method and may come off.



Pull the toggle completely through and tighten the knot around the toggle.



CLEANING THE PARACHUTE ASSEMBLY

CLEANING THE PARACHUTE ASSEMBLY

OVERVIEW

Washing a parachute is not recommended unless deemed absolutely necessary. Washing a parachute can weaken and/or increase the permeability of the fabric. Washing can also cause shrinkage in the nylon fabric, tapes and the cotton/Nomex® components (i.e., bridle attachment area). Do not dry clean parachutes. Parachute components may be spot cleaned or cleaned as a unit and care must be taken that the cleaning process does not do more damage than the original soiling.

This chapter also covers identification and removal of some types of contamination. Items such as acid, salt water, and petroleum products are covered.

HANDWASHING (IF ABSOLUTELY NECESSARY)

1. A mild soap or soap solution, and a water softener may be used.
2. Immerse the parachute into clean, fresh water contained in a smooth vessel, such as a bathtub.
3. Do NOT wring the parachute fabric. Damage to fabric permeability will result.
4. Gently move items by hand until all air pockets are removed. Agitate as little as possible or damage to fabric permeability will result.
5. Empty the vessel of dirty water and refill with fresh warm, clear water.
6. Rinse the parachute several times in warm, fresh water until rinse water is clear.

DRYING A PARACHUTE

The procedure for drying a parachute is as critical as the procedure for washing it. Asymmetric shrinkage may occur if the parachute is dried unevenly.

1. Remove pilot chute assembly and/or drogue/slider control line.
2. Hang parachute full-length or the seams may experience uneven shrinkage creating a turn in the parachute.
3. Hang reserve parachute assembly by all four connector links for the same time.

ACID CONTAMINATION

Nylon that has been contaminated by acid may have irregular shaped spots of gray or dead white color. The acid-contaminated fabric may also become powdery when scraped lightly.

Parachute components suspected of acid contamination may be tested with blue litmus paper. Dampen the suspect area with distilled water. Then lay the litmus paper on the area in question. If the paper turns pink, acid is present. Be careful not to touch the litmus paper. Touching the paper can cause an erroneous response.

If an area tests positive for acid and the effected area is known to be localized, that area should be neutralized with a solution of distilled water and ammonia. Household ammonia will work. Ammonia will not damage nylon or hardware. The damaged area should be removed and the resulting hole should be



patched. If the extent of contamination cannot be determined or if it effects large portions of the parachute, the parachute should be first destroyed then disposed of.

REMOVAL OF SALT WATER CONTAMINATION

Crystals of dry salt and the presence of pale brown, circular stains often evidence salt-water exposure. If the parachute is allowed to dry after salt-water immersion without being rinsed in fresh water, salt crystals will form causing damage to the fabric and suspension lines.

1. Parachutes exposed to salt water should be rinsed out several times in warm, fresh water in a smooth tub. Use of a water softener is recommended. Hang assembly in drying tower in accordance with the section above entitled "Drying a Parachute."

The maximum complete salt-water immersion limits for the parachute are listed below. The parachute assembly should be cleaned within 8 hours of immersion.

Remove from service any parachute assembly or sub-assembly for any of the following conditions:

1. Immersion in salt water for more than 6 hours if the parachute contains cadmium-plated parts.
2. Immersion in salt water for more than 24 hours if the parachute contains stainless steel parts (i.e., slider stops).
3. Immersion in salt water and cannot be cleaned for 36 hours.

REMOVAL OF PERSPIRATION

Perspiration causes damage to the parachute much like salt water does. Small amounts are not significant and may be ignored. For larger areas heavily contaminated, clean the parachute in accordance with the "Removal of Salt Water Contamination" section above.

REMOVAL OF FRESH WATER

Dry parachute assembly in accordance with the section above entitled "Drying a Parachute."

REMOVAL OF MILDEW

1. Wash affected area with mild soap and water solution.
2. Rinse affected area thoroughly with fresh, clear water.
3. Hang assembly in drying tower in accordance with the section above entitled "Drying a Parachute."

REMOVAL OF FIREFIGHTING AGENTS

Parachute fabric and webbing exposed to light water, protein foam, PKP, and any combination of such shall be thoroughly washed within 30 hours after exposure. Hang assembly in drying tower in accordance with the section above entitled "Drying a Parachute."

Metallic parts or components so exposed shall be disassembled as far as practical, washed, dried, and examined. Metallic components treated in this manner may be returned to service if undamaged.

Remove from service any parachute assembly or sub-assembly for any of the following conditions:



1. Contamination by soda-acid firefighting agent. Hardware items may be returned to service after cleaning.
2. Contamination by firefighting agents such as light water, protein foam, PKP or any combination of such, if not decontaminated within 30 hours. Hardware items may be returned to service after cleaning.

REMOVAL OF PETROLEUM PRODUCTS

Hydrocarbons usually do not harm nylon. Petroleum products such as oil or grease have a greenish or brownish appearance. Wash affected area by repeated applications of mild soap and water solution. Each application shall be followed by a rinse in clean, fresh water.

1. Continue washing and rinsing affected area until clean.
2. Hang assembly in drying tower in accordance with the section above entitled "Drying a Parachute."

REMOVAL OF BLOODSTAINS

1. Soak the stained area in cold water.
2. Hand wash affected area with mild soap and water solution.
3. Rinse affected area thoroughly with fresh clean water.
4. Hang assembly in drying tower in accordance with the section above entitled "Drying a Parachute."

REMOVAL OF SOIL

1. Hang the canopy and shake to remove most of the dirt and sand.
2. Brush lightly with a soft-bristled brush.
3. If the assembly is extremely contaminated, perform the following:
 - a. Wash only the soiled areas in warm water with a mild soap.
 - b. Rinse affected area thoroughly with fresh clean water.
4. Hang assembly in drying tower in accordance with the section above entitled "Drying a Parachute."



REPAIR LIMITATIONS

REPAIR LIMITATIONS

OVERVIEW

This section contains some limitations to adhere to when performing parachute repairs.

REPAIR QUALIFICATIONS

Minor Repairs - a senior rigger or country's equivalent may perform minor repairs.

Major Repairs - a master rigger or country's equivalent may perform major repairs.

Factory Repairs - these repairs may only be performed at the PD factory. These include all repairs that are not specifically listed as minor or major repairs.

PATCHES

Holes or snags smaller than the size of one ripstop box (1/8 inch, 3.2mm) may remain unrepaired as long as no more than one hole exists within any 10-inch (25.4cm) circle. A maximum of three such holes or snags per cell are allowed.

Ripstop tape is not authorized for use on Performance Designs reserve parachutes. If the damage is enough to warrant a repair, a sewn repair must be performed.

Darning is not a means of repairing Performance Designs parachutes.

Any hole or tear up to 10 inches (25.4 cm) in length may be repaired by a senior rigger as long as the closest area of the completed repair is at least 1 inch from the nearest seam and at least 5 inches from the nearest tape or line attachment. These are minor repairs.

LINES

Any line, tape, or webbing damage is a major repair.

A master rigger may replace lines. However, it is recommended that the factory do these repairs.

Master riggers may perform repairs that do not involve taking apart any bartacks on the canopy. Special bartack patterns are used that are not normally found in the field. In addition, removal and replacement of these stitch patterns usually weakens the fabric to the point that it is necessary to replace the portions of panels. The original templates are needed to complete this correctly.

GENERAL

Reserves may only be repaired using certified materials. All replacement materials must come from the Performance Designs factory. Under-strength thread and fabric is frequently found in the field. The only way to be sure the material meets Performance Designs standards is to obtain them directly from Performance Designs.



BASIC PATCH PROCEDURE

BASIC PATCH PROCEDURE

OVERVIEW

The Raghanti Basic Patch is recognized as the preferred patching method throughout the industry. The patching method does not require pins nor does it require a measuring square.

The Raghanti Basic Patch can be made in almost any size as long as it falls within the limitations for patches (listed in "Limitations" section below). This chapter will focus on a 6-inch practice patch as the example. This size patch may be used to repair small damage to the parachute. "Small damage" would be approximately 2 square inches (5.08 sq cm) in size.

LIMITATIONS

A senior rigger (or country's equivalent) is qualified to repair any damage up to 10 inches (25.4 cm) in length as long as the closest area of the completed repair will be:

- At least 1 inch (2.54 cm) from the nearest seam, and
- At least 5 inches (12.7 cm) from the nearest tape or line attachment.

Small snags and holes smaller than 1/8-inch square (one ripstop box) located further than 10 inches (25.4 cm) from the closest line attachment may remain unrepaired as long as there are no more than one in any 10-inch (25.4 cm) diameter circle. A maximum of three such snags per cell are allowed.

Ripstop tape is not authorized for use on Performance Designs reserve parachutes. If the damage is enough to warrant a repair, a sewn repair must be performed.

EQUIPMENT AND SUPPLIES NEEDED

- Marking pencil
- Single needle sewing machine with "E" thread
- Ruler
- 7-inch (17.8cm) square piece of fabric for the patch
- 13-inch (33 cm) fabric piece (on which to sew the practice patch)
- Hemostat
- Scissors
- Nippers



PROCEDURE

Locate the damage on the fabric (ex. circles and lines in the photograph). Once the damage has been identified, draw a box around it to define the damage area. The boundary for this particular area of damage is approximately a 2-inch square.

Find the center of the damage and mark it with an "X".

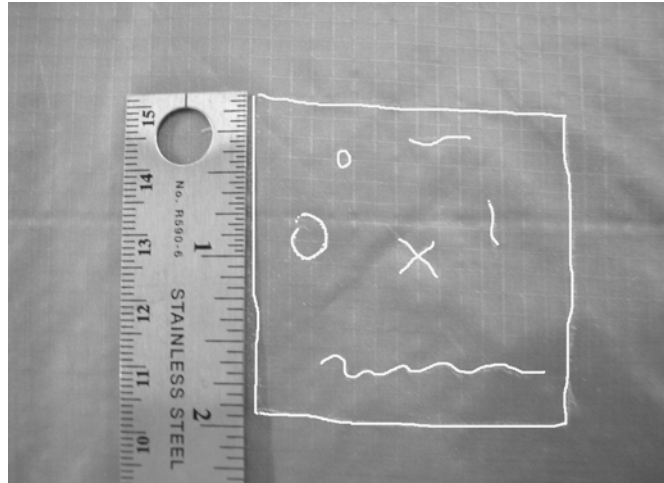

Allow approximately 2_ inches from each boundary side for repair work. This includes a _-inch seam allowance.

Measure half the patch size (in this case, 3 inches) to the left of the damage center. Follow one rip stop line in the fabric as a guide.

At 3 inches out make a center and left border mark (resembling a "T" turned 90° counterclockwise). The center mark will be on the ripstop line (which was followed out 3 inches) and the left border mark will be perpendicular to the center mark. Go 3 inches up from the left center mark and place a top left corner mark.

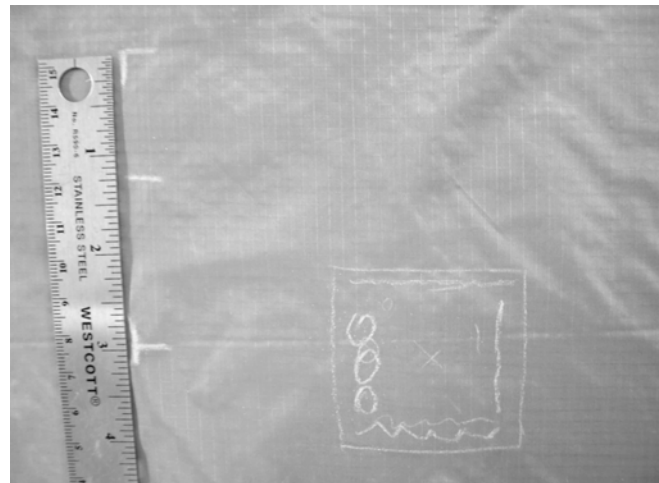

Count down 10 ripstop boxes from the top border and make a mark. This is the starting point.

Count 14 rip stop boxes down on the 7-inch fabric (patch) piece and make a mark. This is the starting point.

Align the starting marks on both pieces of fabric.



Fold the patch material under four ripstop boxes. Hold this 4-block seam allowance with the hemostats.

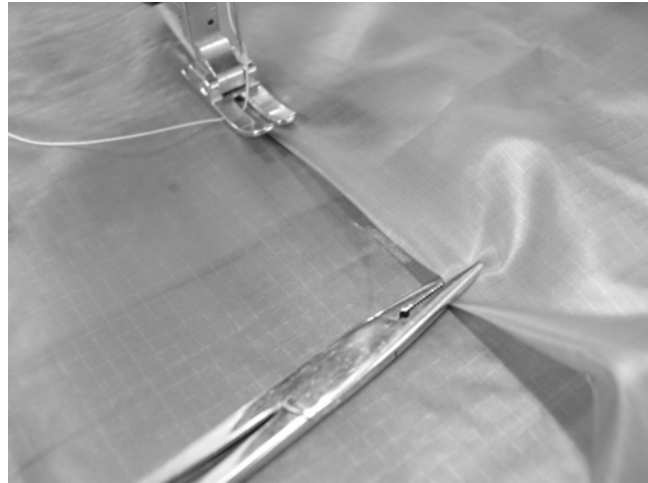

Disengage the puller if one exists on the sewing machine. This gives the person sewing more control over the fabric to prevent slippage and bunching.

Lower the foot and needle into the fabric. While using one hand to hold the two pieces of fabric taut in front, use your other hand to help feed the fabric thru the machine.

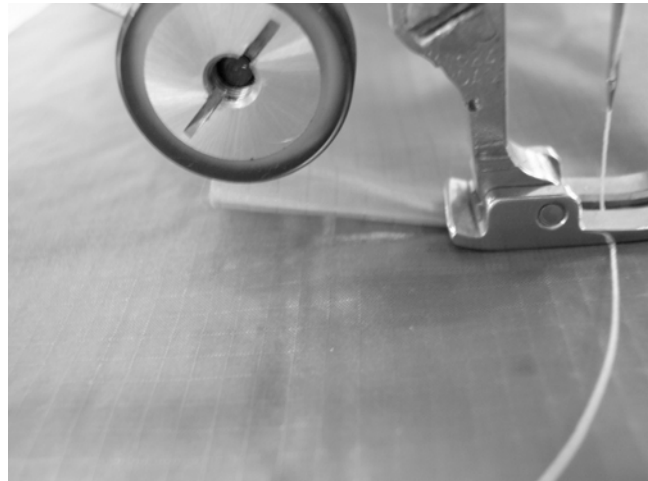

Sew to approximately 2 inches from the corner. Fold the 4-block seam allowance under for the second side creating a corner. Hold with the hemostats.



Make sure to set the hook in the stitch loop before lifting the foot to turn a corner. Sew to 1 block from the edge and turn the corner.



Sew the second side to 2 inches from the corner. Fold the 4-block seam allowance under for the third side creating a corner. Hold with the hemostats.

At this point make sure that the third and fourth sides will align properly before sewing.

Sew the third side, then the fourth side as shown.



Perform a 4-6 inch oversew.



Using scissors cut the damage out along the ripstop lines 7 boxes in from the stitching holding the patch on. Placing the hand between the patch and parachute while trimming (like wearing a mitten) will prevent damaging the patch with the scissors.

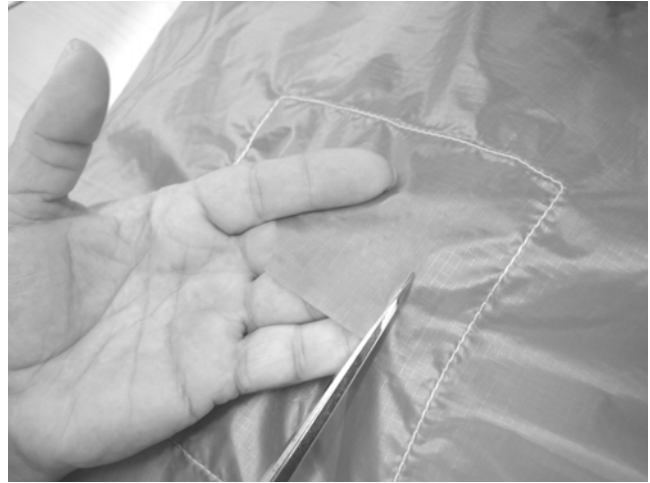

Make a diagonal cut in each corner to 3 ripstop boxes from the corner.

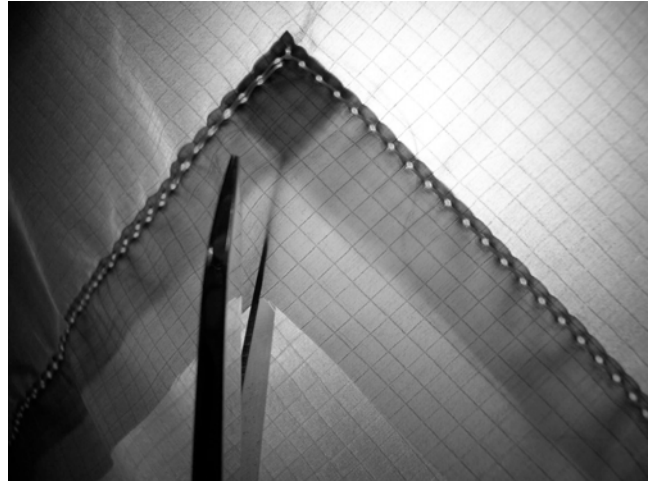

Place the work under the sewing machine. Using the hemostats clamp 1 ripstop box in from the cut edge.



Place the parachute fabric behind the fold back of the patch forming a French fell seam. Do this in two places and seat the 1 box fold back against the patch stitch row with the tip of the hemostat. Sew around the parachute patch repeating this process on each side.



Take care that each corner is fully seated and square.

Use the side of the presser foot as a guide for stitching.



Inspect the work thoroughly.

(PAGE INTENTIONALLY LEFT BLANK)

LINE REPLACEMENT

LINE REPLACEMENT

OVERVIEW

Damaged suspension lines shall not be repaired. A Master Rigger or his equivalent should replace the lines. Also, lines shall be replaced in pairs to minimize any asymmetrical line trim issues that may result from a single line replacement. Any line, tape, or webbing damage is classified as a major repair and therefore can only be performed by a Master Rigger or his equivalent.

REQUIRED EQUIPMENT AND MATERIALS

- Replacement lines from manufacturer
- V-T-295 size E nylon thread of the same color as used on the rest of the lines
- Bar tack or zig-zag machine
- Scissors
- Seam ripper
- Finger trapping needle

COMPLETE STEERING LINE REPLACEMENT

PROCEDURE

1. Remove the damaged steering line.
2. Starting with the outboard side, attach the new line to the parachute using the same knot as used on the other lines.
3. Bartack the fingertrap. Ensure the bartack originates at the fingertrap entry and extends toward the live side of the fingertrap.
4. Repeat steps 1 through 3 to attach all upper steering lines to the parachute.
5. Thread the lower steering line through the slider and steering line guide ring on the riser and tie to the steering toggle or loop.
6. Apply even tension and adjust all knots. Recheck all measurements.
7. Inspect the work thoroughly. Double check line lengths.
8. Perform a line continuity check.



LOWER STEERING LINE (LST) REPLACEMENT

PROCEDURE

1. Remove the damaged lower steering line.
2. Place the new lower steering line through the lower loops of the upper steering lines.
3. Fingertrap the line back into itself, ensuring the marks on the line match up.
4. Bartack the fingertrap ensuring it originates at the fingertrap entry and extends toward the live side of the fingertrap.
5. Attach bottom end of the lower steering line to the rapide link in the same location as the damaged lower line.
6. Perform a continuity check.

SUSPENSION LINE REPLACEMENT

The line being replaced will either be an A/B line or a C/D line. These lines come from the factory as follows:

- The "A" portion of the A/B line and the "C" portion of the C/D line will have a prefabricated loop for parachute attachment. (see picture)
- The "B" portion of the A/B line and the "D" portion of the C/D line come straight line (without a loop) and cut at an angle for finger trapping.

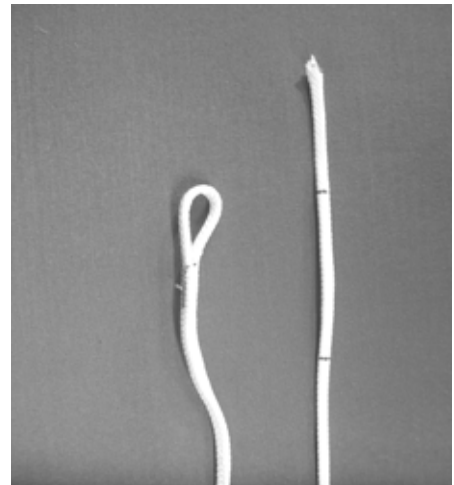

PROCEDURE

1. Remove the damaged line.
2. Attach either the A or the C line (depending on which line is being replaced) to the parachute using a lark's head knot.
3. Attach either the B or the D line (depending on which line is being replaced) to the parachute by wrapping the line around the parachute attachment loop to resemble a lark's head knot.
4. Verify the finger-trap match marks are aligned. This ensures the line is at its proper length.
5. Fingertrap the line back into itself, ensuring the marks on the line match up.
6. Bartack the fingertrap. Ensuring it originates at the fingertrap entry and extends toward the live side of the fingertrap.
7. Perform a line continuity check.
8. Repeat steps 1 through 7 for the line opposite the damaged line to ensure symmetry and trim.

(PAGE INTENTIONALLY LEFT BLANK)

SECTION 4:
PACKING INFORMATION

REPACK CYCLE

Currently, up to one-year repack cycles are authorized for Performance Designs reserve canopies when cared for properly. Proper care includes keeping the entire system clean, dry, limited exposure to UV light, not overheating, and no exposure to degrading elements. Performance Designs reserves the right to extend or reduce repack intervals based on continued research and field experience. You must use the shortest repack cycle of the your country's applicable legal requirements, harness/container manufacturer's requirements, and AAD manufacturer's requirements. Your new Performance Designs reserve canopy must be assembled inspected and packed into your parachute system by a certificated rigger. Even if you live in a country where it is legal for you to assemble and maintain your reserve, you should let an experienced and appropriately rated person that is familiar with this reserve, your harness/container and all other components of the parachute system perform the assembly and repack.



**PACKING INSTRUCTIONS FOR HR-360-R2
RESERVE PARACHUTE**

PACKING INSTRUCTIONS FOR HR-360-R2 RESERVE PARACHUTE

OVERVIEW

If the rig manufacturer specifies a packing method other than the ones shown, and the rig manufacturer authorizes its use for this specific parachute, you may decide which instructions to follow. Otherwise you must follow the Performance Designs instructions. It is recommended that you follow the instructions for the packing method with which you are most familiar.

Inspect the parachute thoroughly before starting to pack it, following the inspection instructions described in Maintenance and Repair Section of this manual. Check the line continuity, and ensure the parachute has been assembled on the rig correctly.

PACKING INSTRUCTIONS

Flake the parachute out on its side until all the T-seams are aligned from leading edge to trailing edge. Set the brakes according to the rig manufacturer's instructions.

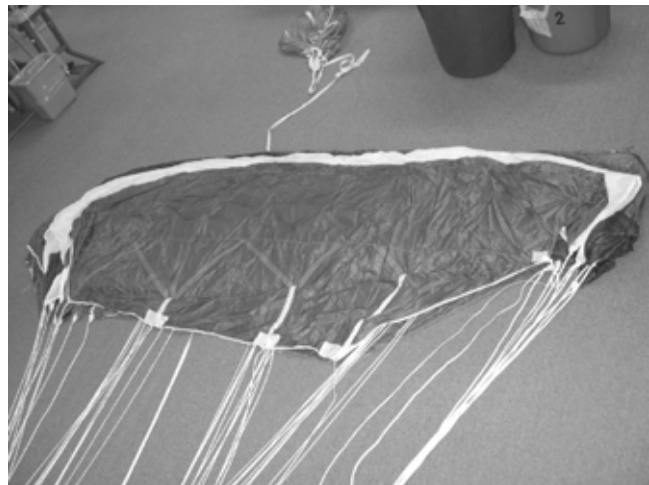

Crouch next to the risers and face the parachute. Be sure there are no twists in the risers. Slip the fingers of your left hand between each left hand riser and between the left hand steering line and the risers. Do the same with your right hand.



Move up the lines, allowing them to slide between your fingers. Lift the parachute off the ground ensuring lines are not twisted and parachute is facing the correct direction.



Starting with the end cell nearest your legs, flake the nose. Once the entire nose is flaked, tuck it between your knees and hold it there.



Clear the stabilizers. Flake the material between each line group out toward the stabilizers, keeping the line groups stacked together in the middle of the pack job. Clear the tail, flaking the material between each steering line toward the outside of the pack job.

Hold the parachute parallel to the floor with the nose facing down. Continue to hold the lines in one hand while using your free arm to support the parachute fabric. While maintaining even tension on the lines, gently place the parachute back down on the floor or packing table with the nose facing down.



Starting on the right side of the parachute, carefully lift the folds of material back towards the center of the pack job until the nose is exposed. Clear the four cells to the right of the center cell and flake this section of the nose toward the outside of the pack job.



Flake the material between the A and B lines away from the line channel in the center of the pack job. Be sure all four T seams to the right of the center cell are neatly flaked.

Find all bottom seams to the right of the center cell and flake them out toward the stabilizer. Be sure the right side B lines are grouped together and stacked neatly on top of the A lines. Smooth out the fold between the A and B lines.



Repeat the previous steps to flake the material from between the B and C lines on the right side.

Flake the material between the C and D lines away from the line channel in the center of the pack job. Make sure the D lines are grouped together and stacked neatly on top of the A, B, and C lines. It is important to keep even tension (in the direction of the arrow) on all the line groups throughout the remainder of the pack job. Pulling on the T seams directly above the line attachment points will help keep the lines straight and maintain the folds in the material.

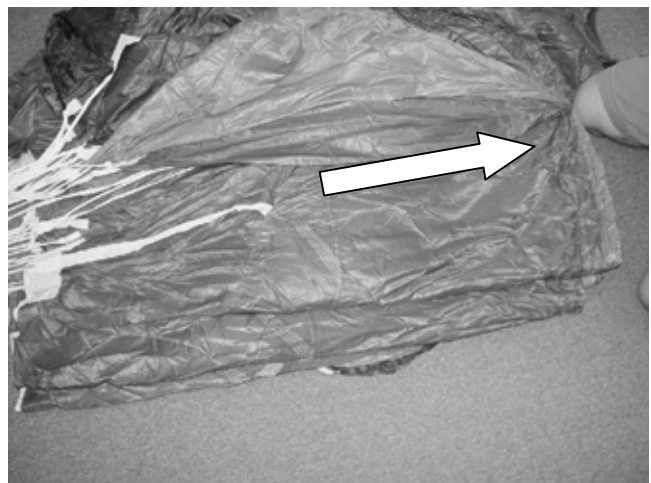

Flake the material between the upper control lines toward the outside of the pack job, leaving the control lines stacked neatly on top of the A, B, C, and D lines.

Repeat the previous steps to flake and clear the left side of the parachute. Make sure the line channel in the center of the pack job is clear.

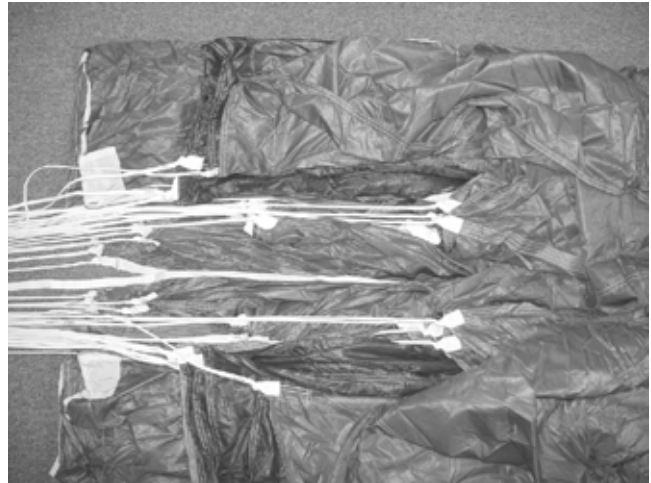

From the top of the parachute, pull the bridle (which attaches the reefing drogue chute to the slider) until the slider comes to a stop against all four of the slider grommets.

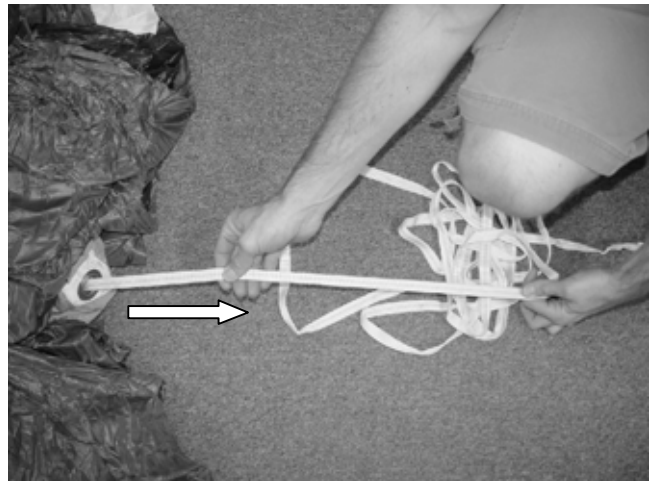

Make sure the slider grommets are seated against the slider stops sewn into the stabilizers. Ensure the fabric of the slider is pulled upwards into the air channel, and the slider is quartered.

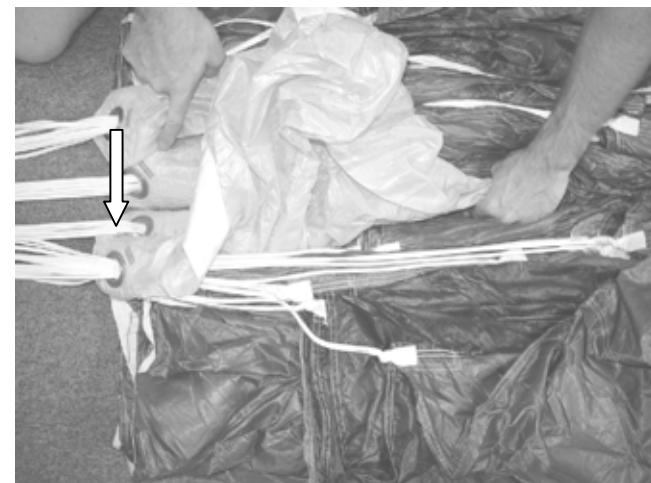

Going back to the flaked material, fold the material between the A and B lines in half (folding underneath towards the center of the pack job). Do not go beyond the line attachment points. This step is called a reduction and decreases the width of the parachute pack to better fit the bag.

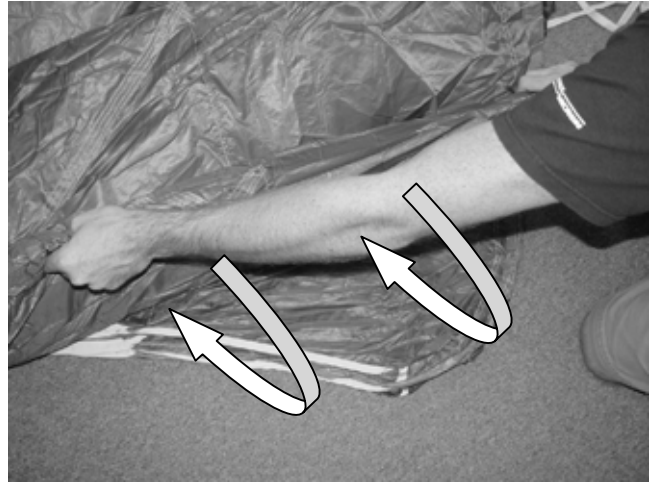

Repeat the previous steps to flake the material between the B and C lines and again between the C and D lines.

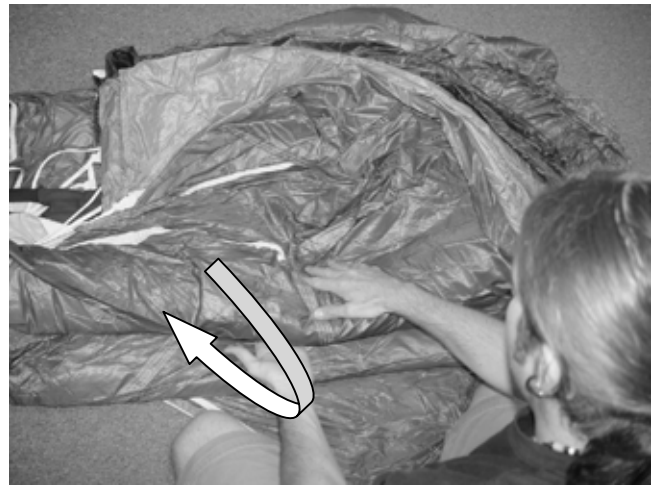

Flake the material between the upper control lines toward the outside of the pack job, leaving the control lines stacked neatly on top of the A, B, C, and D lines.



Dress the center of the tail by spreading out the top center panel to the width of the parachute underneath.



Fold the flaked tail section of the canopy under to achieve the same width as the rest of the canopy. Use the center cell material to cocoon around the tail section. The flaked tail section folds and center cell material are folded around the B to D material and tucked in behind the A to B material.



View of parachute after tail and all flaked material has been folded.



Fold the leading edge of the nose back and parallel to the edge of the parachute. Then fold the nose under. When the nose folds are complete, the leading edge should be even with the edge of the cocooned parachute.



Prepare the reefing drogue chute for storage in the reserve deployment bag by stretching it out and folding it as shown.



Fold the reefing drogue chute leaving the bridle attachment portion towards the center of the fold. Insert one half of the reefing drogue chute into one side of the drogue stow pocket as shown.



Fold the reefing drogue chute in half again.



Insert the other half of the reefing drogue chute into the drogue stow pocket as shown.



Clear the bridle.



Locate box stitch area at the confluence and place on top center of reefing drogue chute. This configuration is important.

S-fold reefing line as shown 3 times each side.

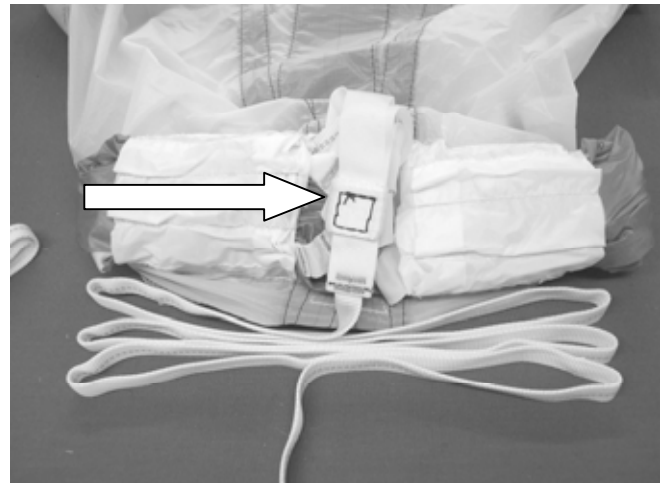

Slide reefing line into each side of the channel.

The order of stows is as follows: upper right (UR), upper left (UL), UR, UL, UR, UL to middle right (MR), middle left (ML), MR, ML, MR, ML to bottom right (BR), bottom left (BL), BR, BL, BR, BL. Each pocket should contain 3 stows which extend to the end of each pocket.



This is a view of how the stowed bridles should look without the bag.



Stowed bridle.



Prepare the bag by inserting locking pull up cord from the top and through the grommets. Secure with one overhand knot.



Cinch down on the locking mechanism.



S-fold the bottom of the reserve parachute up and on top of itself. Ensure the S-fold is long enough to extend from the center grommet of freebag to about 2-3 inches out of the mouth of the freebag.

Using packing paddles to make S-folds will help maintain the line tension and create precision fold lines.

When S-folding the nose under the parachute, make sure the leading edge remains exposed, but does not extend past the edges of the folded parachute.



Leave the packing paddles in place to prepare for the next half S-fold. Clamps may be used to help maintain control of the fabric.

Dress center cell to the width of the pack job.



Place the reserve bag in position in front of the parachute.



Kneeling on the lower tail, pull the top of the folded reserve up onto your lap. Make sure the nine leading edge openings are exposed and that the tail is not wrapped in front of the openings. Lay the parachute back down and redress in preparation for inserting it into the free bag.



Remove all packing paddles.

Fold top flap over the canopy so the safety stow at the edge of the top flap (see photo) aligns with the grommets closest to the canopy with the bottom flap.



Holding one end of the safety stow with your little finger (see arrow in photograph), pass the other end through the grommet of the bottom flap ...





...and pass the loop through the respective grommet on the side flap.



Temporarily secure the locking stow using the freebag bridle.



Repeat for the opposite side.



Holding one end of the second safety stow with your finger, pass the other end through the grommet located on the top edge of the bottom flap...



...and pass the loop through the respective grommet on the side flap.



Secure the second locking stow with the first line bight.



Repeat for the other side.



Turn the bag towards you.



Remove the bridle from the locking stow and replace it with the third line bight. Ensure you follow an S-fold pattern while stowing line bights.



Repeat for the last safety stow.



(PAGE INTENTIONALLY LEFT BLANK)

SECTION 5: DRAWINGS



HR-360 WARNING LABEL

WARNING	MODEL SIZE HR-360-R2 SN: HR360-000000																				
<p>THIS IS A HIGH PERFORMANCE PARACHUTE. EVEN NORMAL USE MAY RESULT IN SERIOUS INJURY OR DEATH. TRAINING, PROFICIENCY AND SKILL ARE REQUIRED TO LOWER THE RISK. READ AND COMPLY WITH ALL MANUFACTURER'S MANUALS, RECOMMENDATIONS, PROCEDURES, PLACARDS AND LIMITATIONS.</p> <p>PARACHUTE SYSTEMS SOMETIMES FAIL TO OPERATE CORRECTLY, EVEN WHEN PROPERLY MANUFACTURED, ASSEMBLED, PACKED AND OPERATED. YOU RISK SERIOUS INJURY AND DEATH EACH TIME YOU USE THIS SYSTEM.</p>																					
<p>TRAINING AND PROFICIENCY REQUIREMENTS:</p>																					
<p>DO NOT USE THIS PARACHUTE SYSTEM UNLESS YOU HAVE:</p> <p>A. RECEIVED INSTRUCTION IN THE USE OF THIS SPECIFIC PARACHUTE SYSTEM AND OPERATE IT WITHIN THE STUDENT OR NOVICE LIMITATIONS LISTED BELOW:</p> <p style="text-align: center;">-OR-</p> <p>B. PERFORMED AT LEAST 50 RAM AIR PARACHUTE JUMPS AND AT LEAST 10 SOFT STAND UP LANDINGS, WITHIN THE TARGET AREA, USING A CANOPY NO MORE THAN 15% LARGER THAN THIS SIZE.</p> <p style="text-align: center;">-OR-</p> <p>C. EXPERIENCE WITH THIS EQUIPMENT AND ARE HIGHLY FAMILIAR AND PROFICIENT WITH THE OPERATION, FLIGHT AND LANDING CHARACTERISTICS OF THIS MODEL/SIZE PARACHUTE AND SYSTEM.</p>																					
<p>SKILL AND OPERATING LIMITS (STD. DAY TEMP. AT SEA LEVEL):</p>																					
<p>WEIGHTS LISTED ARE (JUMPER + CLOTHING + EQUIPMENT) LBS (KG).</p> <table border="1" style="width: 100%; border-collapse: collapse; text-align: center;"> <tr> <th>MIN. WT.</th> <th>STUDENT*</th> <th>NOVICE*</th> <th>INT.*</th> <th>ADV.*</th> <th>EXPERT*</th> <th>MAX. WT.</th> </tr> <tr> <td>200 (91)</td> <td>350 (159)</td> <td>350 (159)</td> <td>450 (204)</td> <td>500 (227)</td> <td>550 (250)</td> <td>550 (250)</td> </tr> </table> <p>MAXIMUM DEPLOYMENT SPEED: 180 KTS EAS @ SEA LEVEL</p> <p>* MAXIMUM WEIGHT, TO REDUCE RISKS STAY WELL BELOW THIS WEIGHT.</p> <p>-WEIGHT ADJUSTMENTS FOR LANDING CONDITIONS: REDUCE ALL WEIGHTS BY 2 % PER 1000 FT (300M) LANDING ELEVATION. REDUCE ALL WEIGHTS BY AN ADDITIONAL 1% FOR EVERY 3° C (5° F) ABOVE STD. DAY TEMP., WHICH IS 15°C (59°F) AT SEA LEVEL. STD DAY TEMP. DECREASES 2°C (3.5°F) PER 1000 FT (300M) FOR EACH 1000 FT ABOVE SEA LEVEL.</p> <p>-OPENING FORCES INCREASE WITH ALTITUDE, REDUCE MAXIMUM WEIGHT AND/OR MAXIMUM AIRSPEED (EAS) FOR DEPLOYMENT ALTITUDE.</p> <p>**VARIES WITH WEATHER/LANDING CONDITIONS</p> <p>-APPROVED FOR TANDEM USE MAXIMUM DEPLOYMENT WEIGHT</p>		MIN. WT.	STUDENT*	NOVICE*	INT.*	ADV.*	EXPERT*	MAX. WT.	200 (91)	350 (159)	350 (159)	450 (204)	500 (227)	550 (250)	550 (250)						
MIN. WT.	STUDENT*	NOVICE*	INT.*	ADV.*	EXPERT*	MAX. WT.															
200 (91)	350 (159)	350 (159)	450 (204)	500 (227)	550 (250)	550 (250)															
DATE OF MANUFACTURE - CDATE PN: HR360P02	INSP:																				
REMOVAL OF THIS LABEL VOIDS ALL WARRANTIES																					
<p style="text-align: center;">CANOPY HISTORY LOG</p> <p>EACH TIME THIS CANOPY IS PACKED BUT HAS NOT BEEN JUMPED, MARK A DIAGONAL BAR IN THE NEXT EMPTY BOX: <input type="checkbox"/></p> <p>EACH TIME THIS CANOPY IS PACKED AFTER IT HAS BEEN JUMPED, MARK A "X" IN THE NEXT EMPTY BOX: <input checked="" type="checkbox"/></p> <p>THIS CANOPY MUST RECEIVE A FABRIC PERMEABILITY TEST WITHIN EACH 25 JUMPS AND 40 PACKS. DO NOT REPACK UNLESS THESE REQUIREMENTS ARE MET.</p> <table border="1" style="width: 100%; border-collapse: collapse; height: 40px;"> <tr> <td style="width: 10%;"></td><td style="width: 10%;"></td><td style="width: 10%;"></td><td style="width: 10%;"></td><td style="width: 10%;"></td><td style="width: 10%;"></td><td style="width: 10%;"></td><td style="width: 10%;"></td><td style="width: 10%;"></td><td style="width: 10%;"></td><td style="width: 10%;"></td><td style="width: 10%;"></td><td style="width: 10%;"></td><td style="width: 10%;"></td><td style="width: 10%;"></td><td style="width: 10%;"></td><td style="width: 10%;"></td><td style="width: 10%;"></td><td style="width: 10%;"></td><td style="width: 10%;"></td> </tr> </table>																					
HR-360	MODEL #																				
HR360-CUT REVISION FROM PRODUCTION ORDER	PART #																				
HR360-NUMBER FROM PRODUCTION ORDER	SERIAL #																				



HR-360 FLYING FRONT VIEW

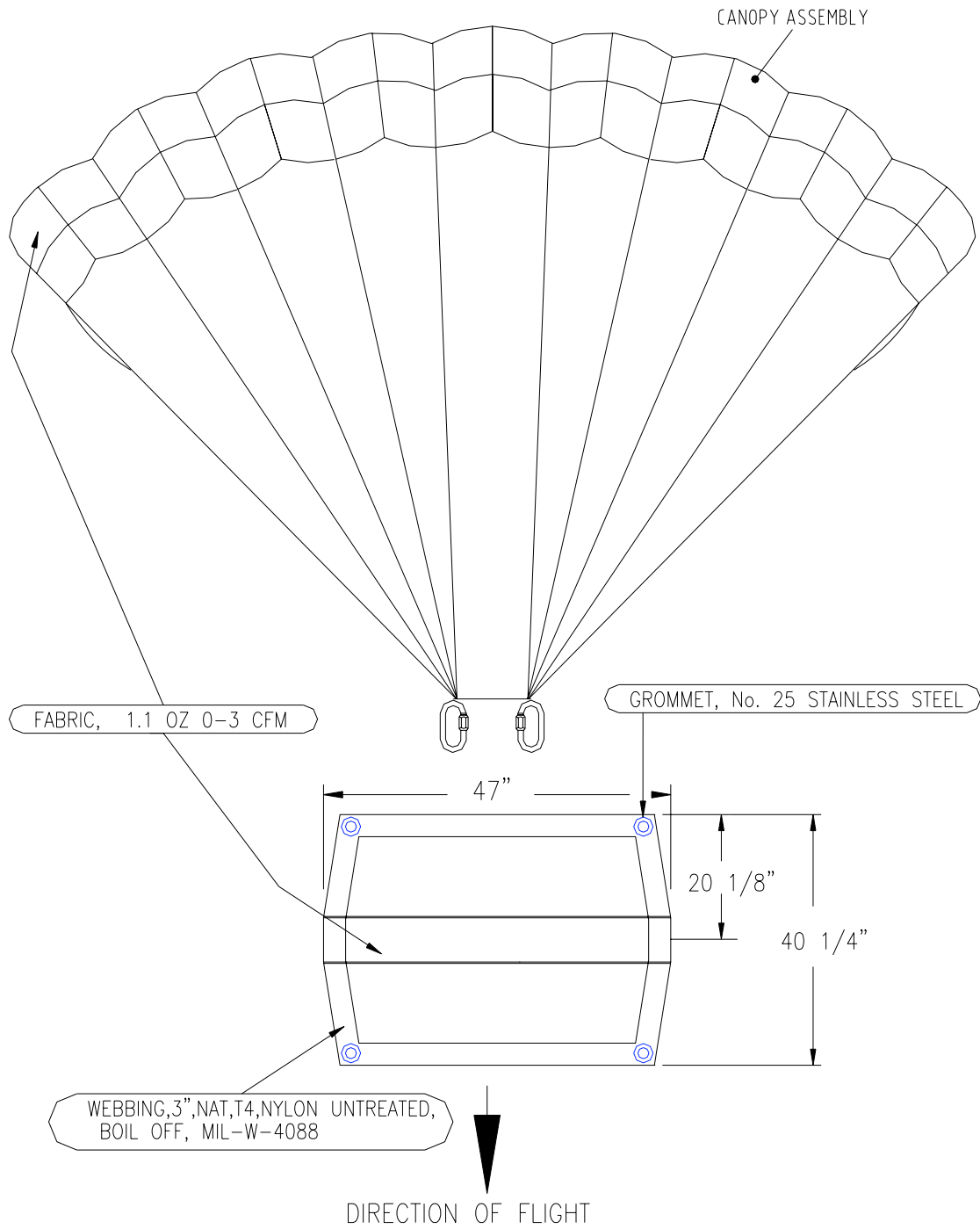

HR-360 FLYING SIDE VIEW

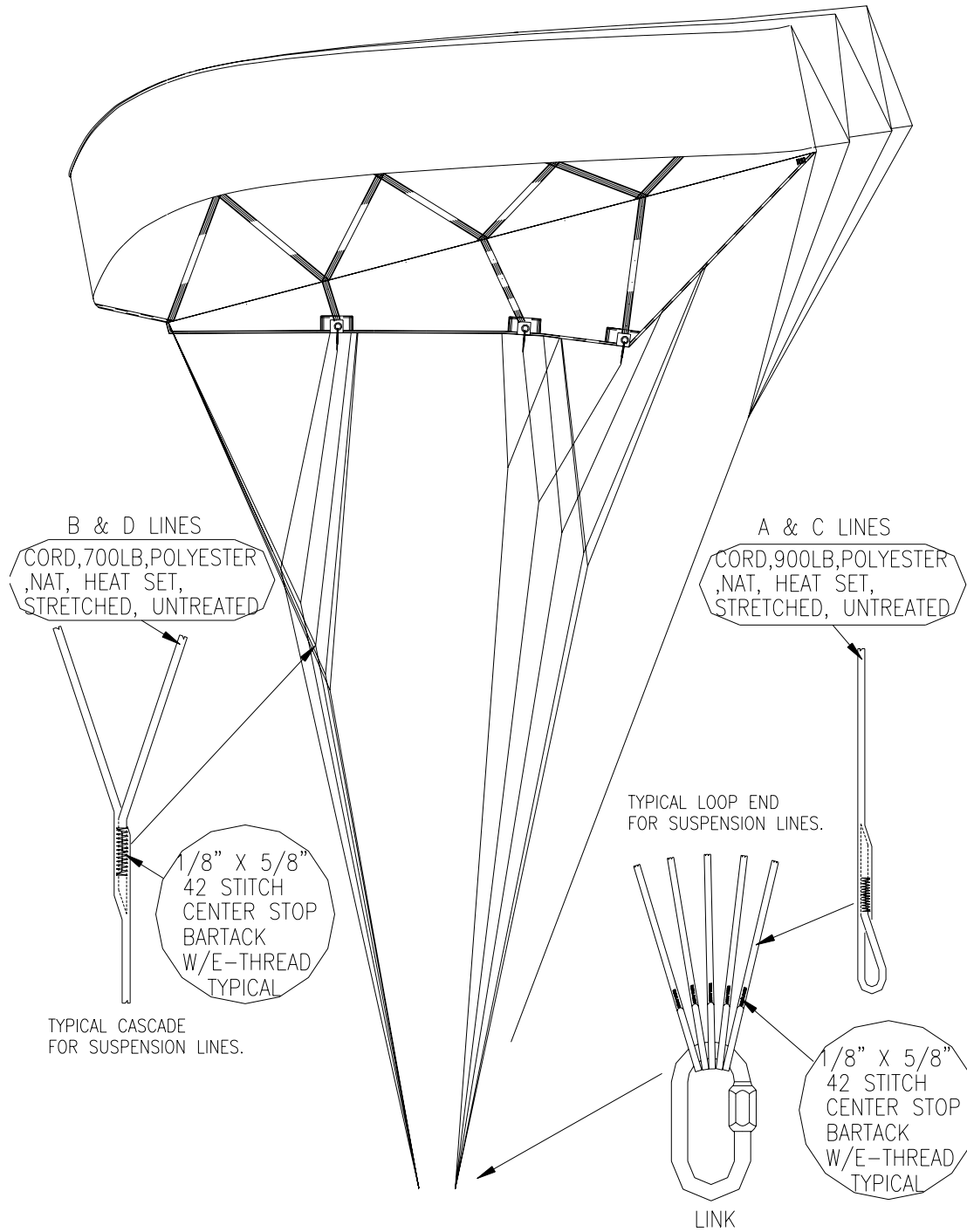

HR-360 PLANFORM

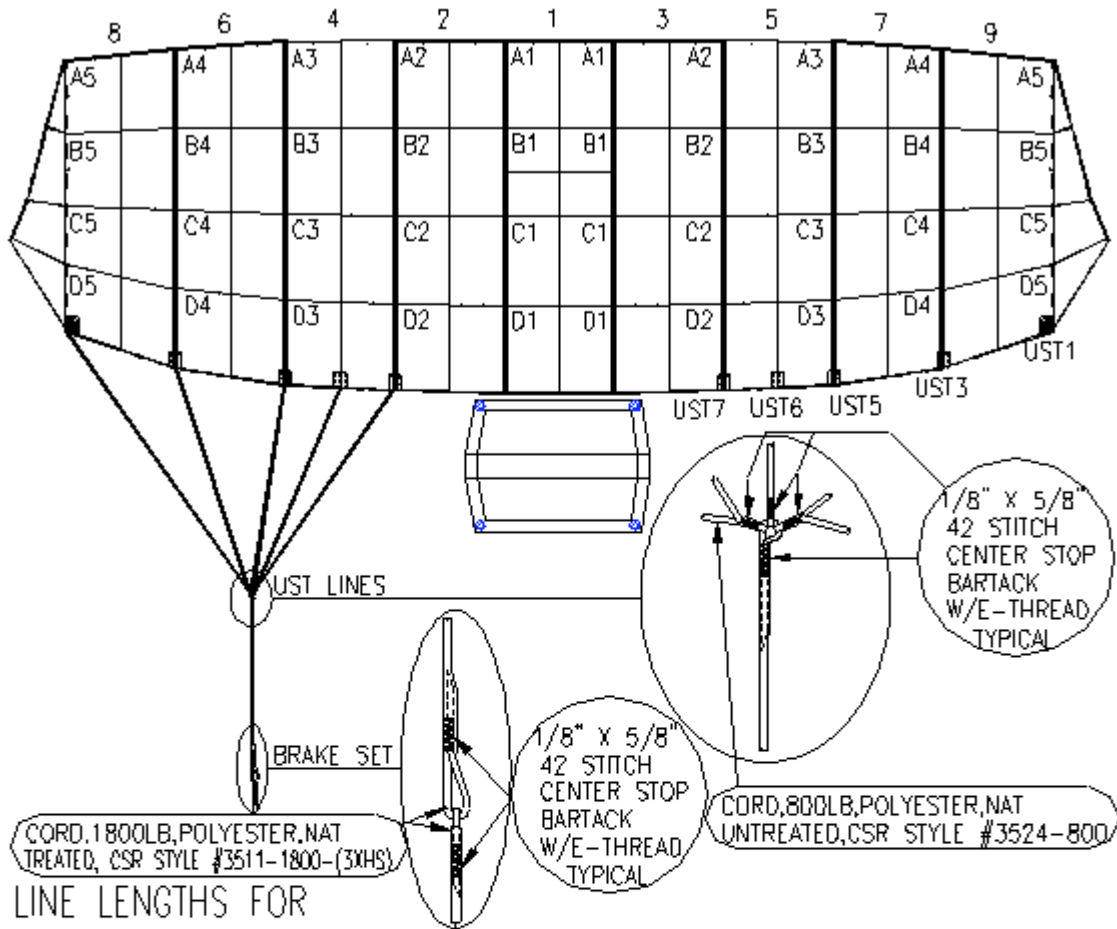

LINE LENGTHS FOR EQUIPMENT INSPECTION

A5 LINE	198"	± 1"	A5 TO B5	27 7/8"	± 1/2"
A4 LINE	197 5/8"	± 1"	A5 TO C5	9 1/2"	± 1/2"
A3 LINE	197 3/8"	± 1"	A5 TO D5	17 1/8"	± 1/2"
A2 LINE	197 1/8"	± 1"	A4 TO B4	23 3/4"	± 1/2"
A1 LINE	197"	± 1"	A4 TO C4	18 1/2"	± 1/2"
			A4 TO D4	21 1/2"	± 1/2"
SEAM TO SEAM TOP SKIN #1	39 1/8" TO 40 1/8"		A3 TO B3	27 7/8"	± 1/2"
B1 TO C1	32 1/4" TO 33 3/4"		A3 TO C3	11 3/8"	± 1/2"
BRAKE TO TOGGLE	23"	± 1/2"	A3 TO D3	23 7/8"	± 1/2"
			A2 TO B2	3 1/8"	± 1/2"
A5 TO UST1	23 1/8"	± 1"	A2 TO C2	11 5/8"	± 1/2"
A5 TO UST3	13 3/8"	± 1"	A2 TO D2	24 3/8"	± 1/2"
A5 TO UST5	11 7/8"	± 1"	A1 TO B1	3 1/8"	± 1/2"
A5 TO UST6	13 1/2"	± 1"	A1 TO C1	11 7/8"	± 1/2"
A5 TO UST7	18 3/4"	± 1"	A1 TO D1	26 5/8"	± 1/2"



HR-360 DAMAGE CHART

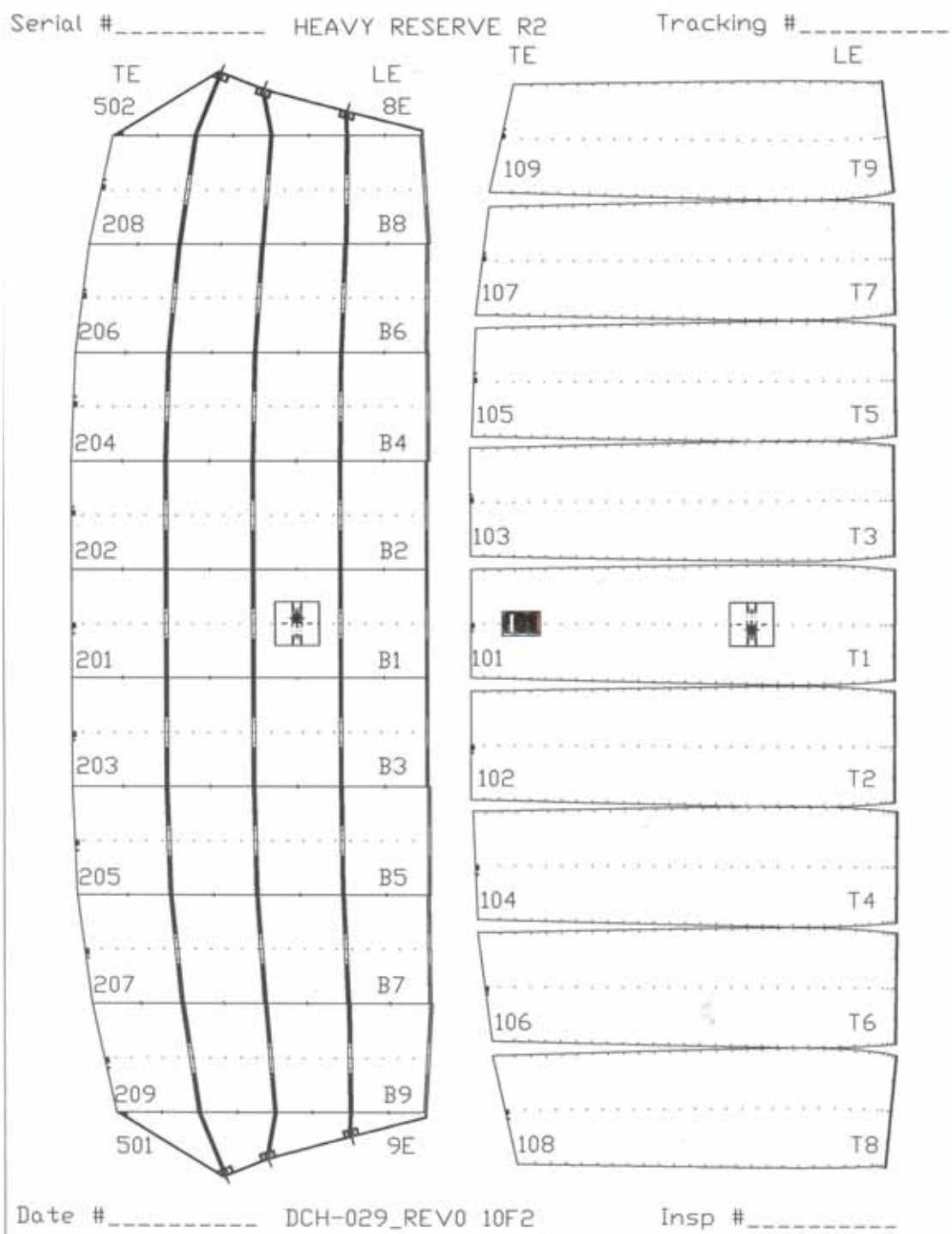

HR-360 DAMAGE CHART

Serial # _____ HEAVY RESERVE R2 Tracking # _____

3A8		8E	408		R8
386		8-6	406		R6
364		6-4	404		R4
342		4-2	402		R2
321		2-1	401		R1
313		1-3	403		R3
335		3-5	405		R5
357		5-7	407		R7
379		7-9	409		R9
39B		9E			

Date # _____ DCH-029_REV0 20F2 Insp # _____

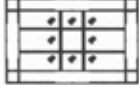
 SLIDER

